

1

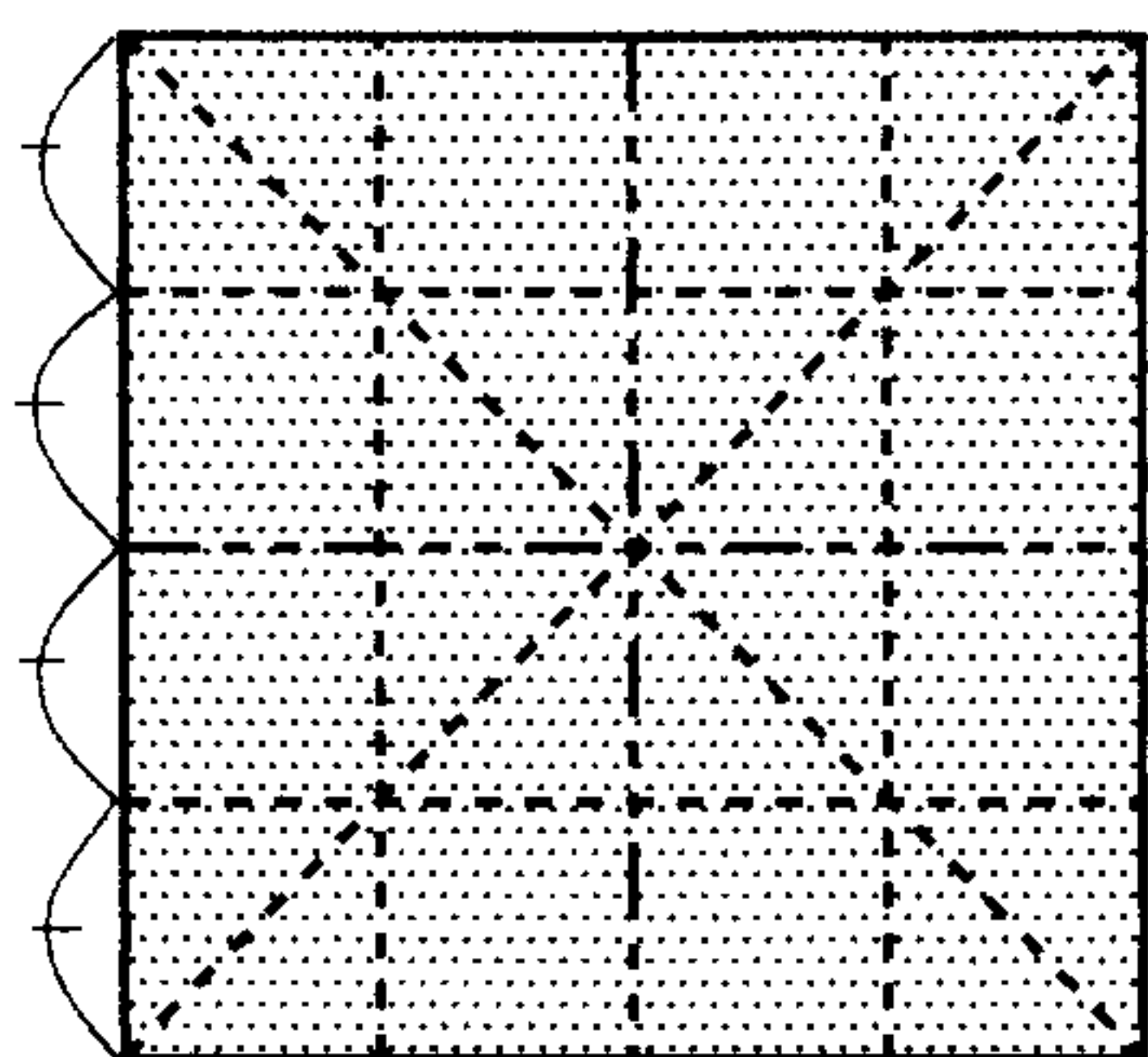

折り目をつけてから  
正方基本形にまとめる

2

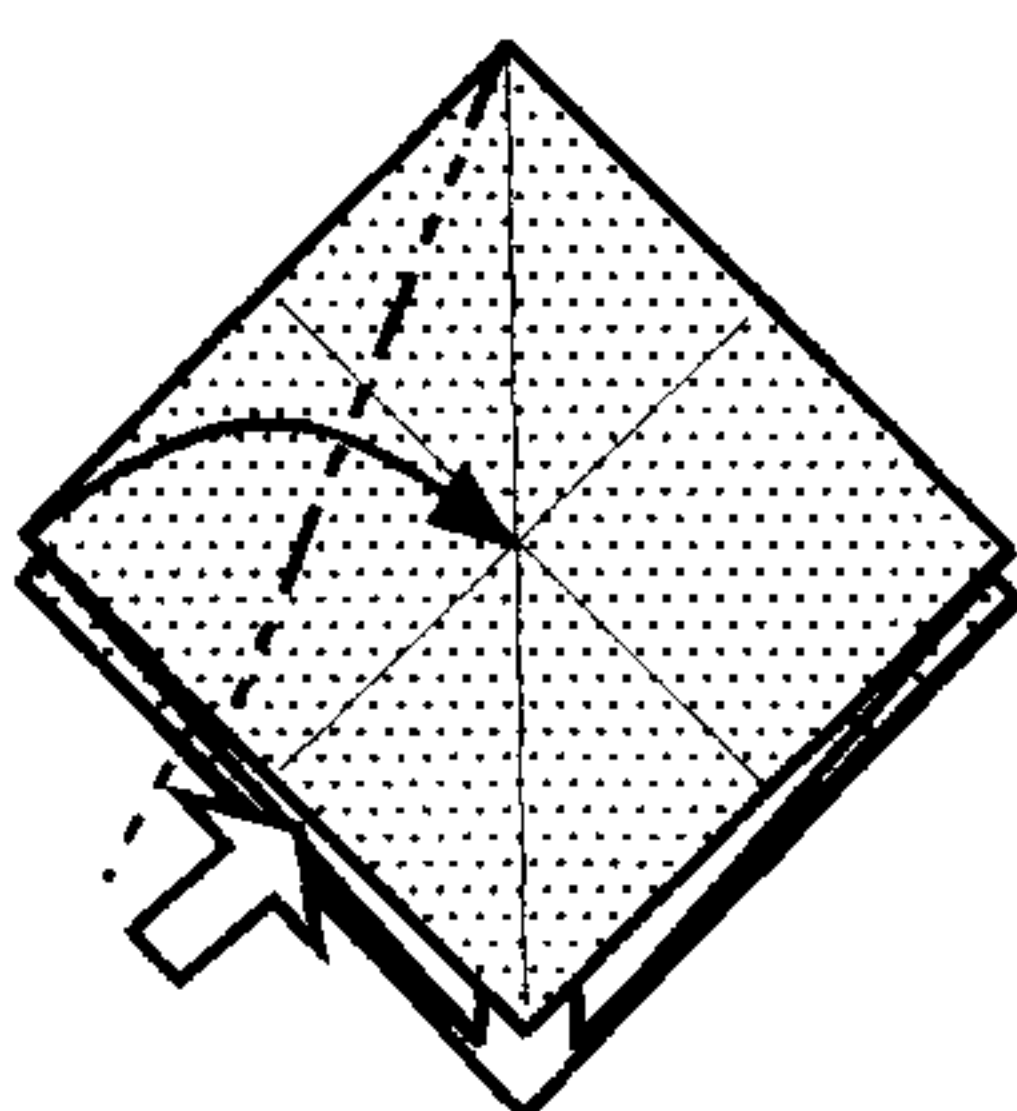

内側を広げてつぶす  
ように折る

3

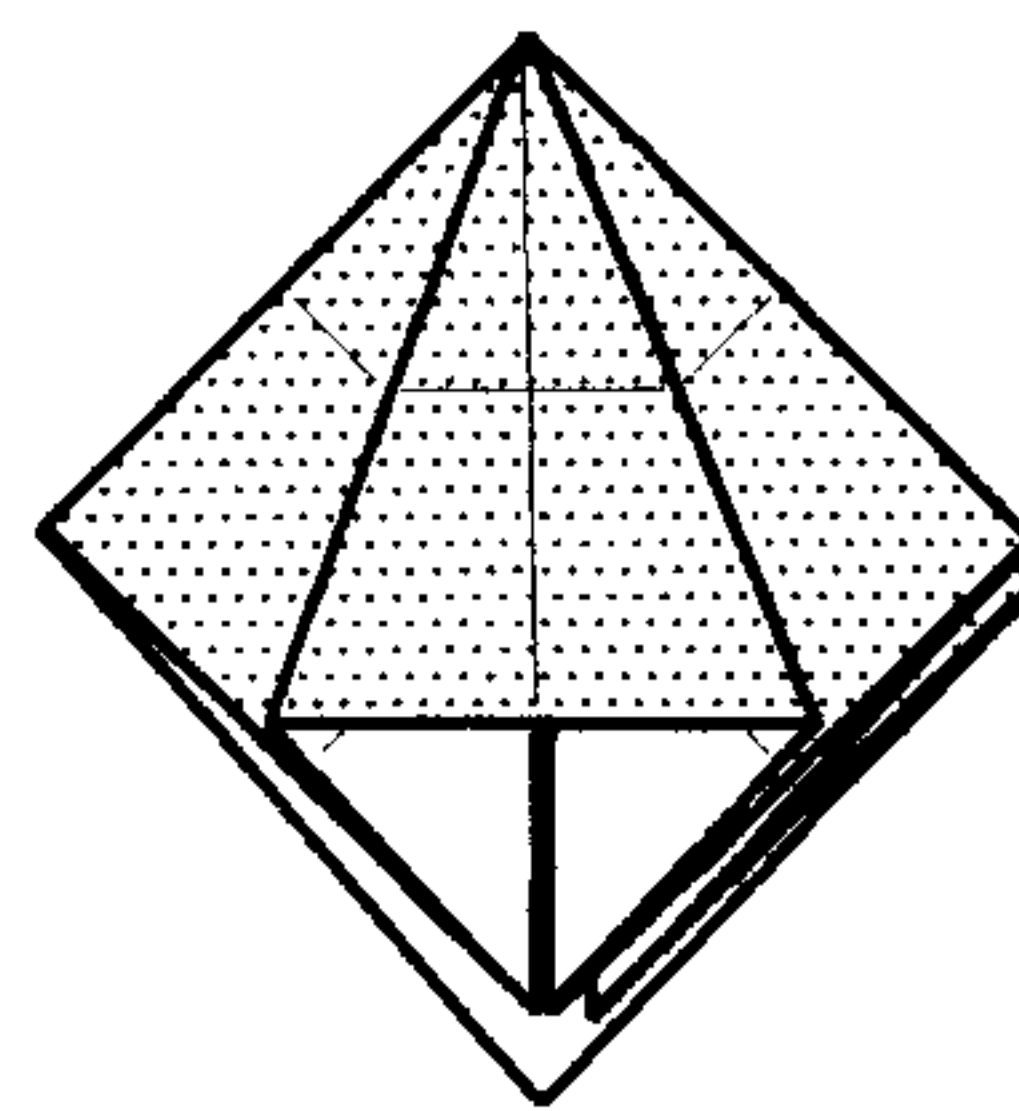

残りの3つの角も2と  
同じように折る

4

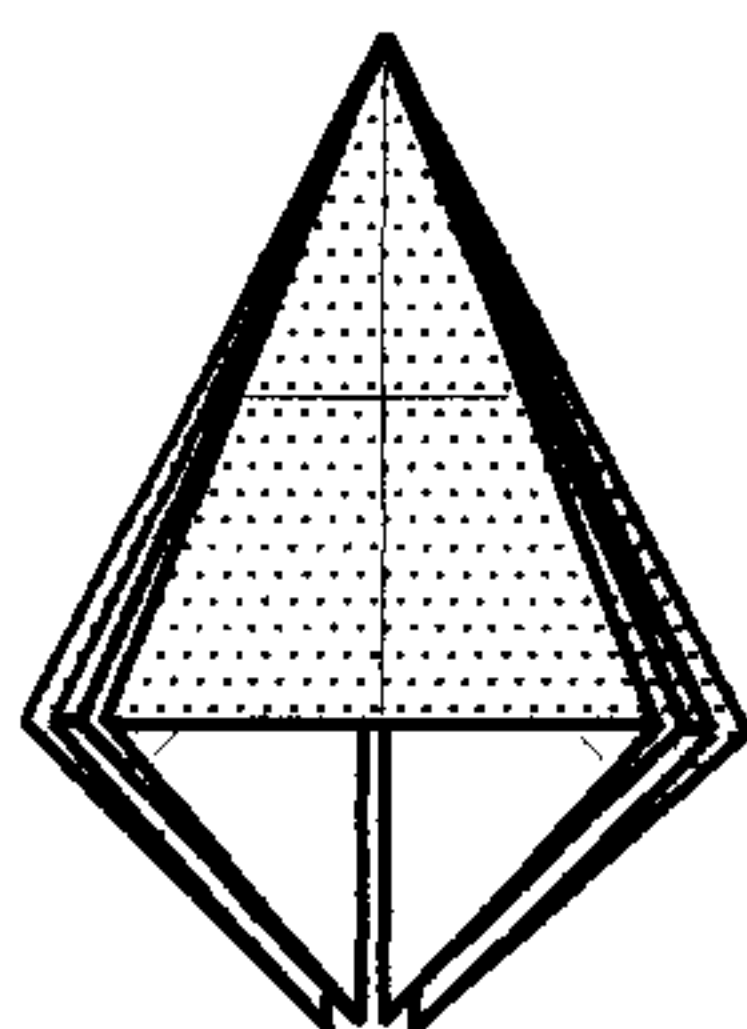

広げて裏面にする

5

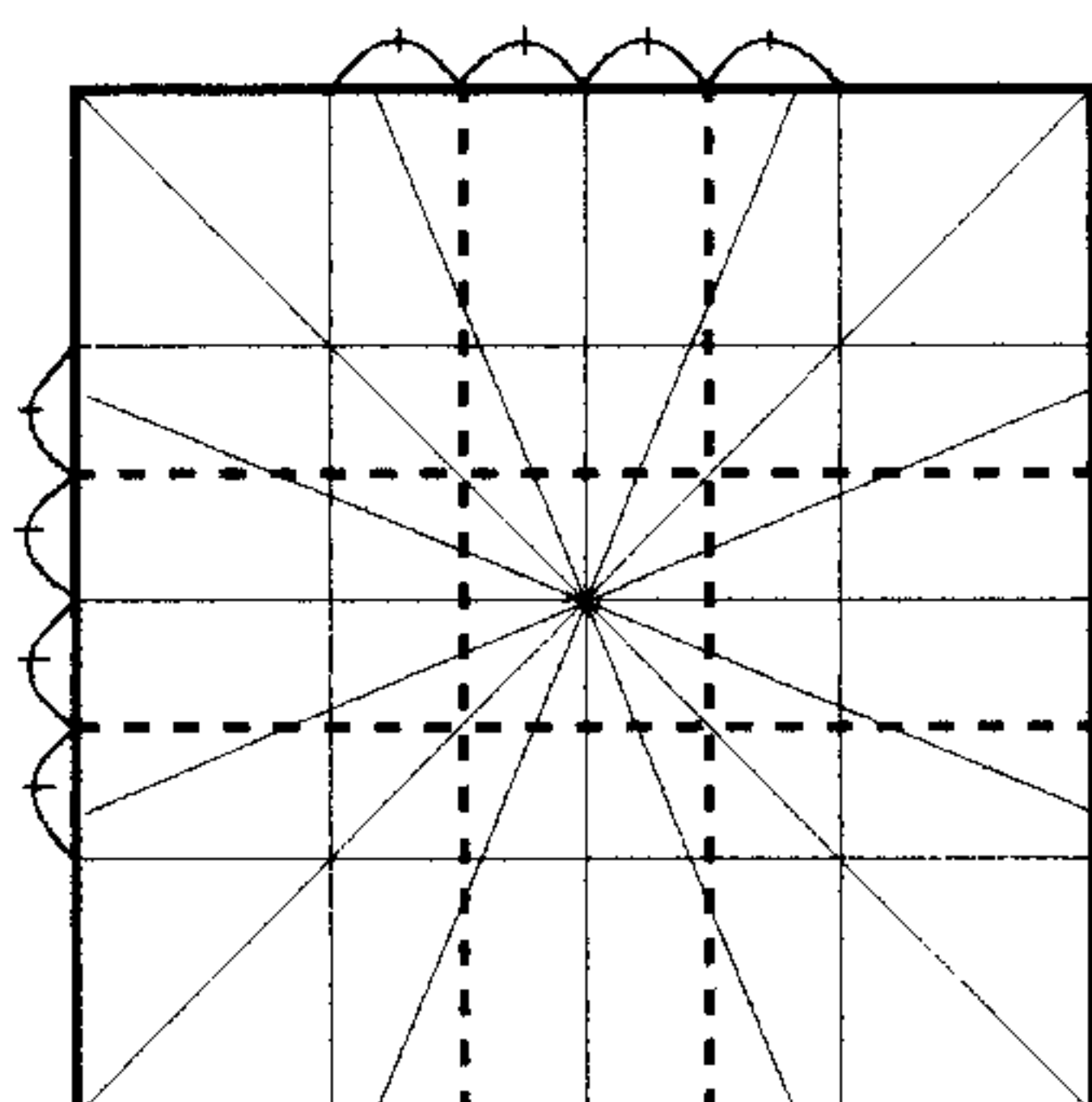

折り目をつける

6

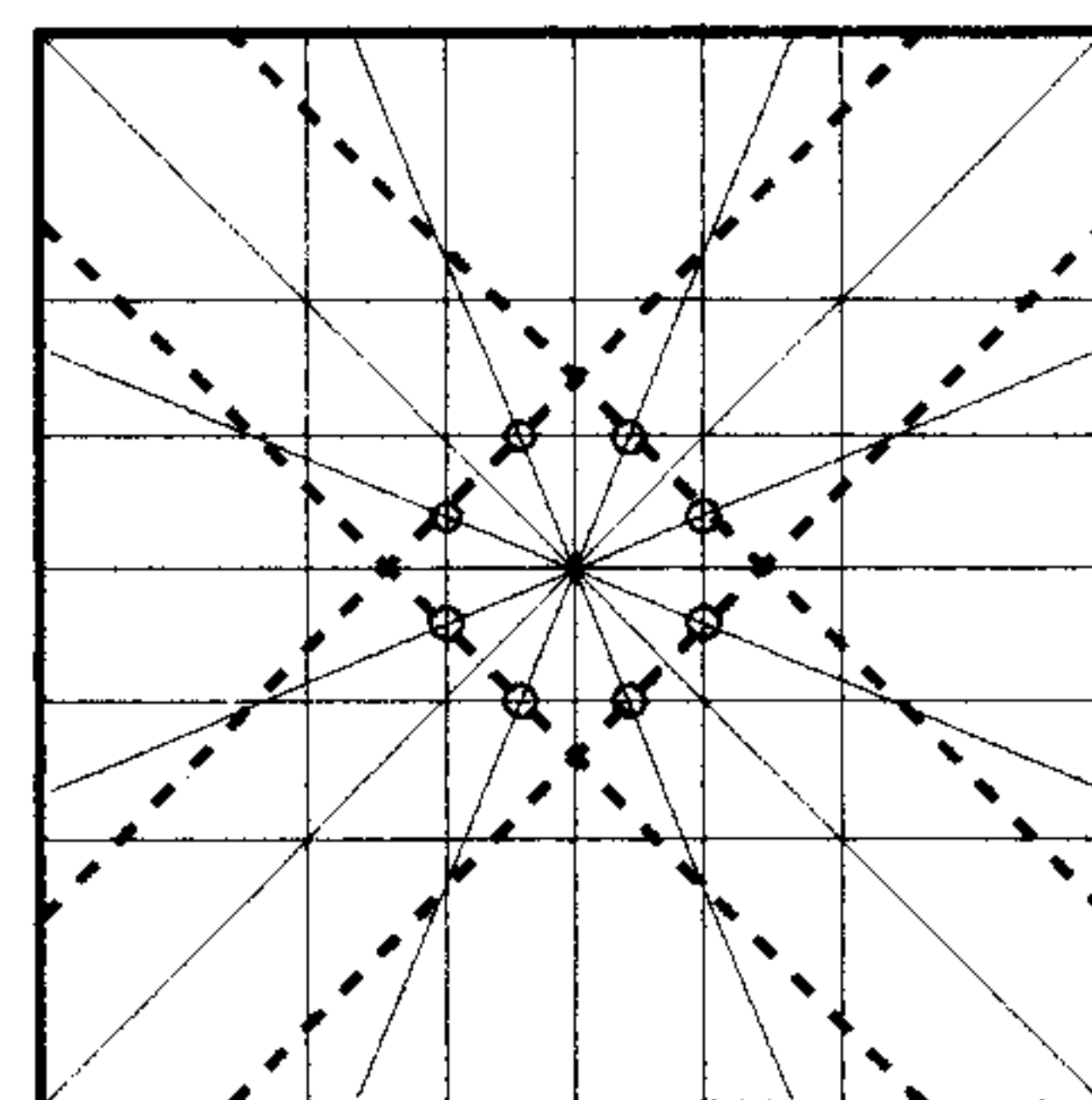

折り目をつける

7

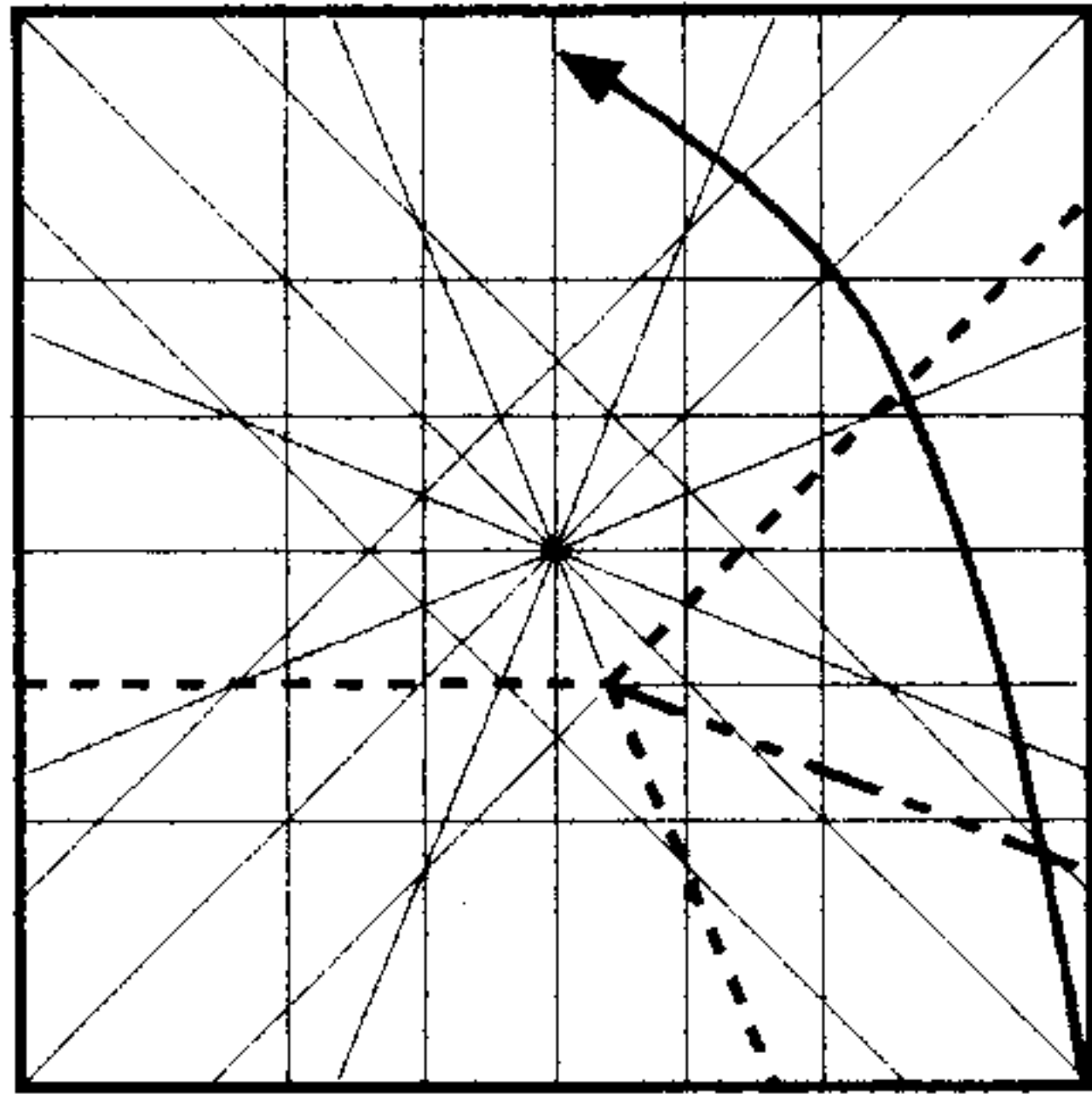

図の谷折り線に沿って折りたたむ（山折り線は折りたたむと自然につく）

8

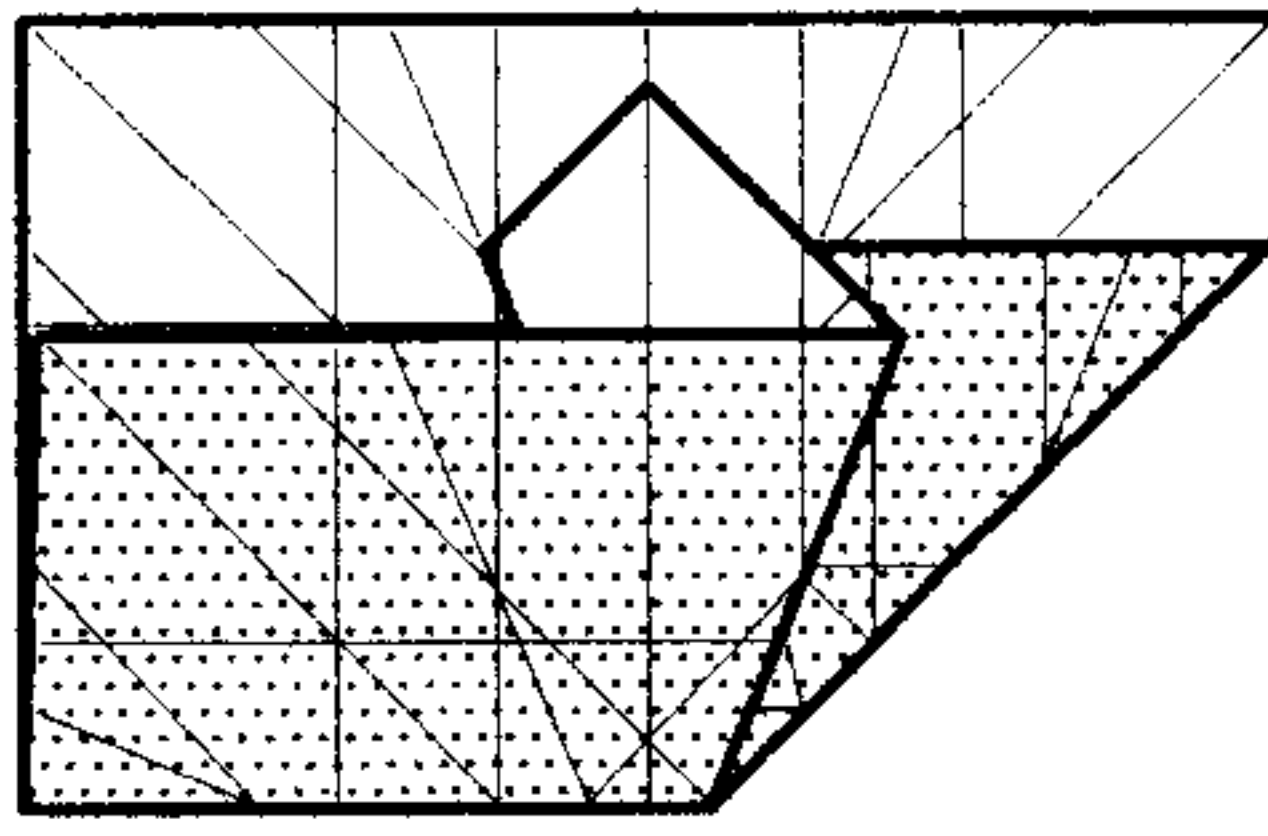

広げる

9

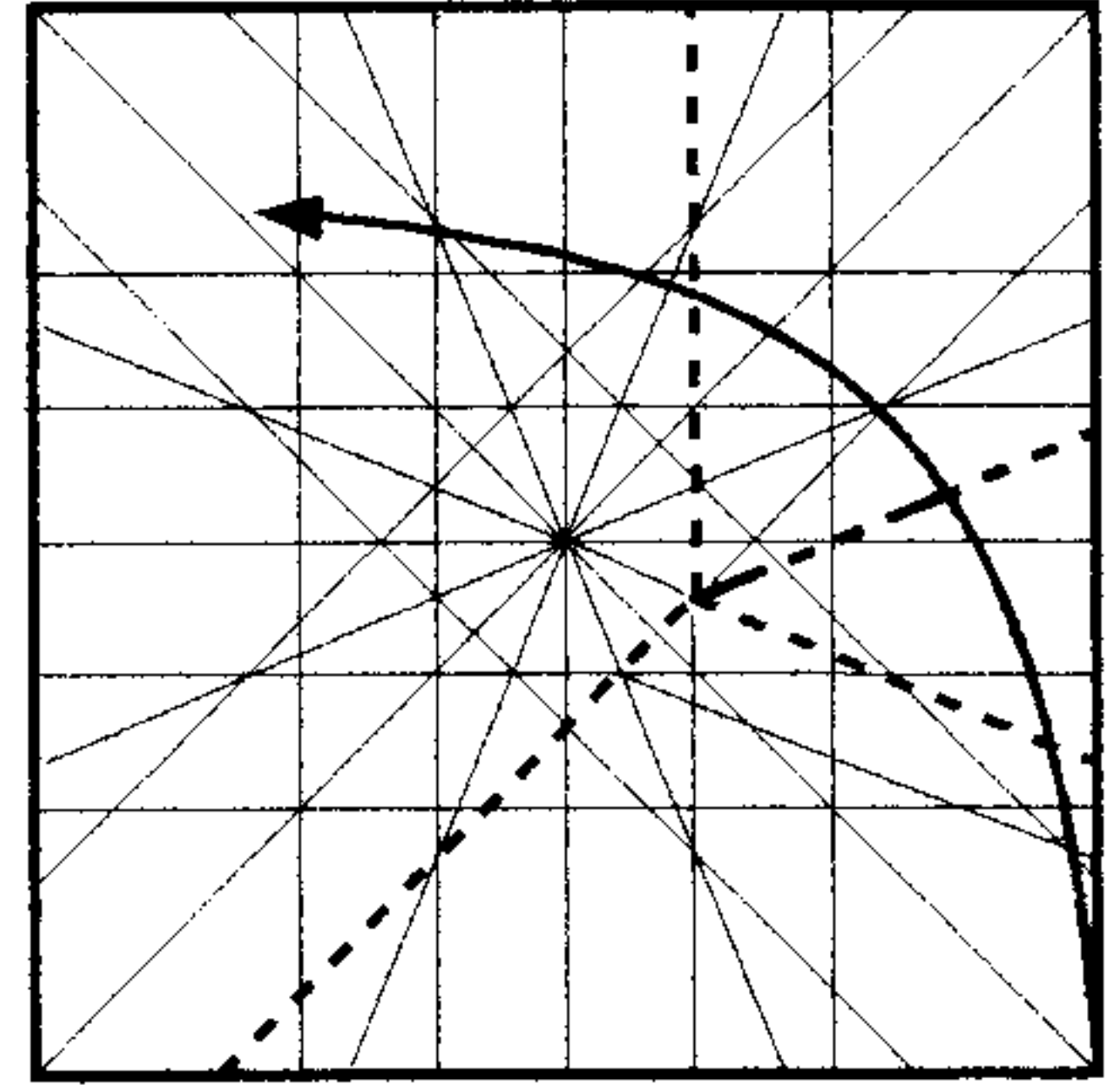

図の谷折り線に沿って折りたたむ（山折り線は折りたたむと自然につく）

10

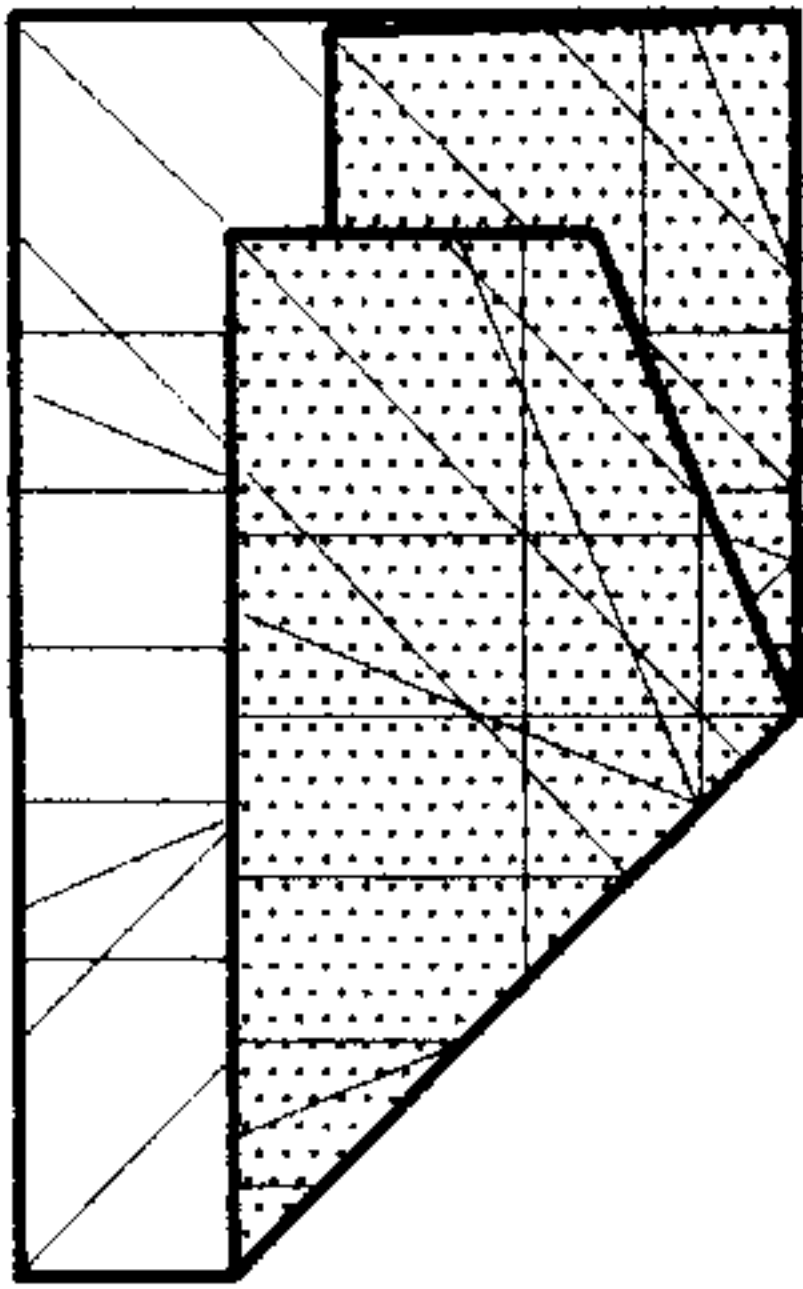

広げる

11

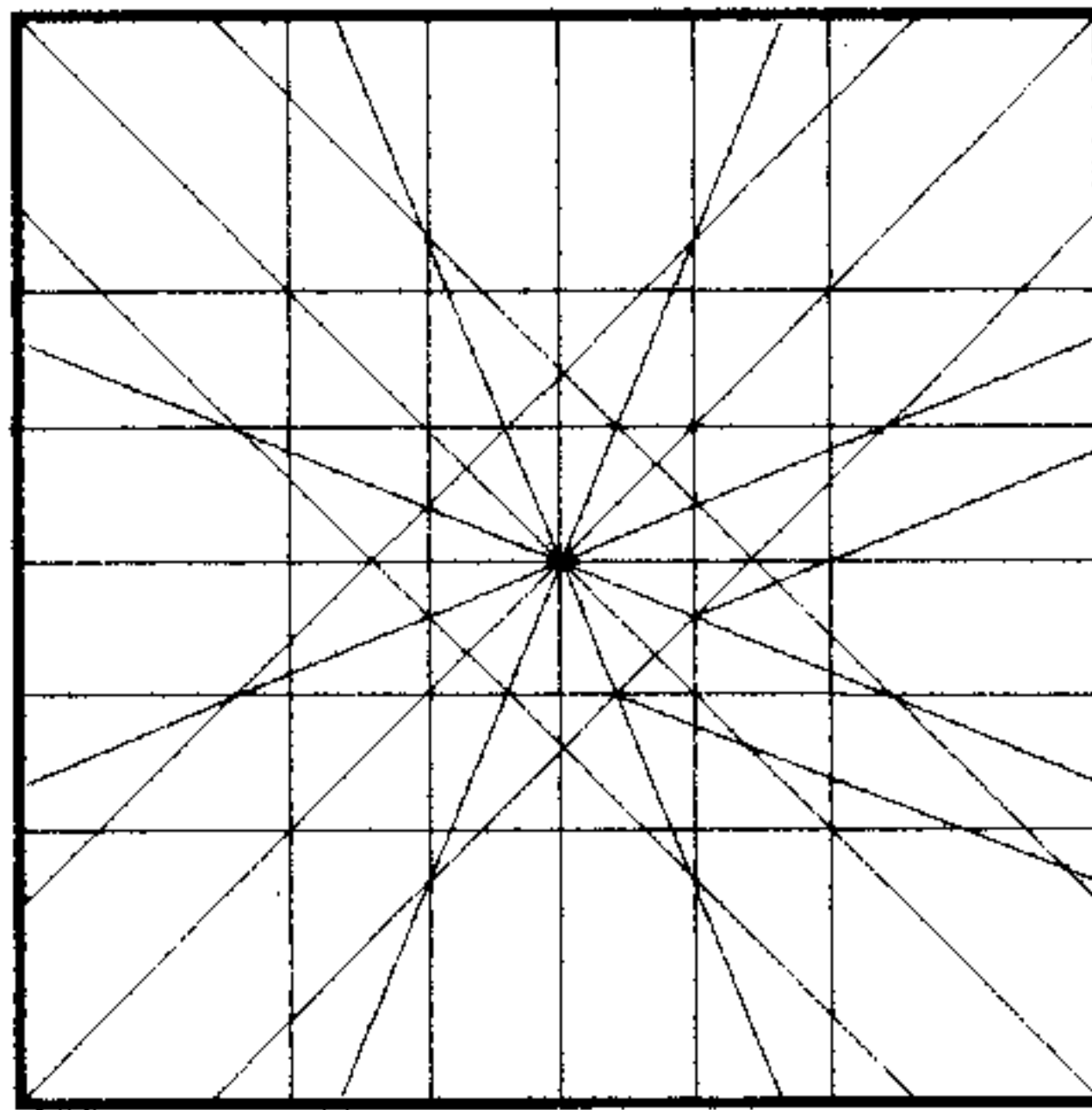

他の3辺も7～10と同様に折る

12

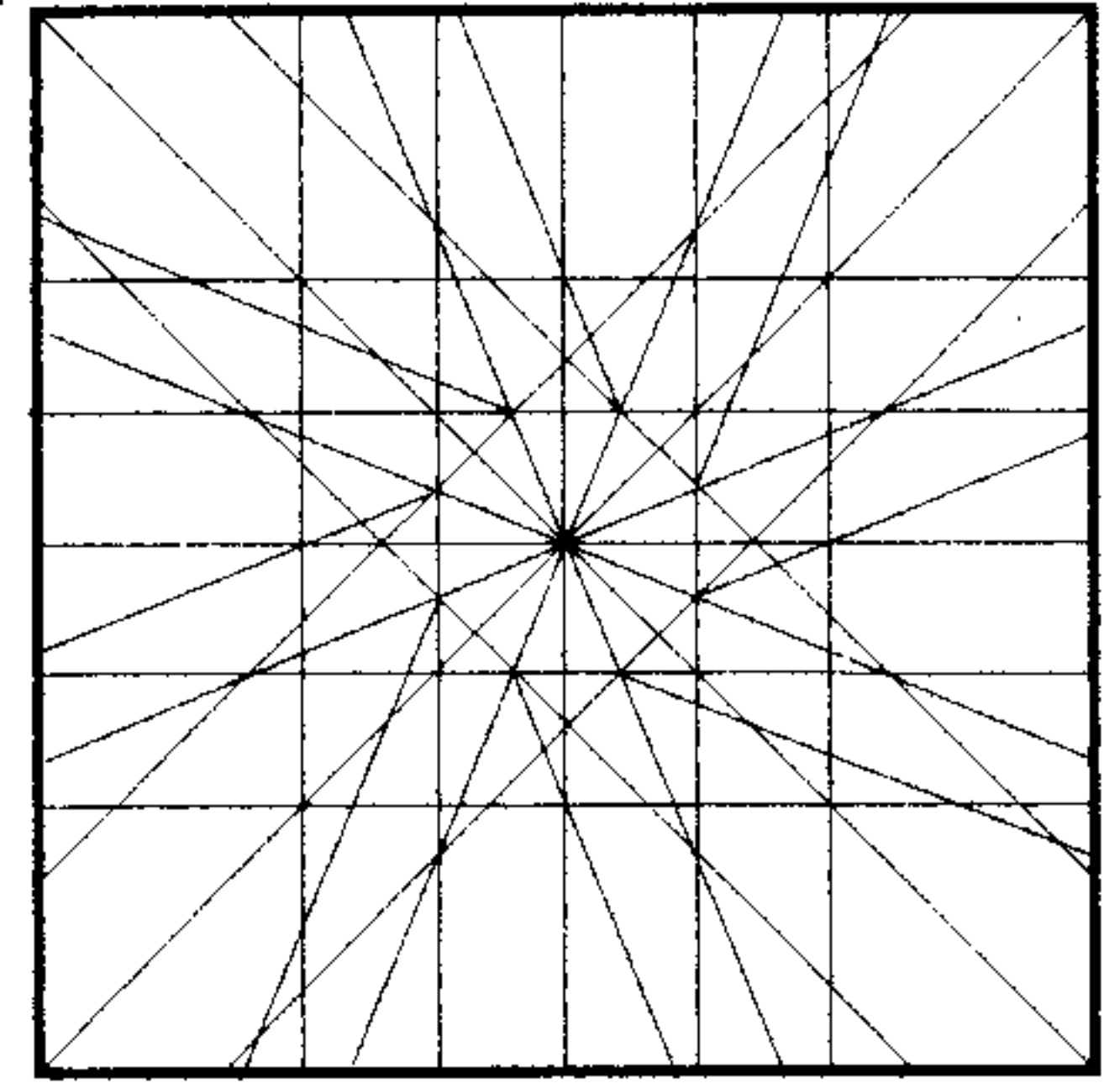

折り目つけ終了

13

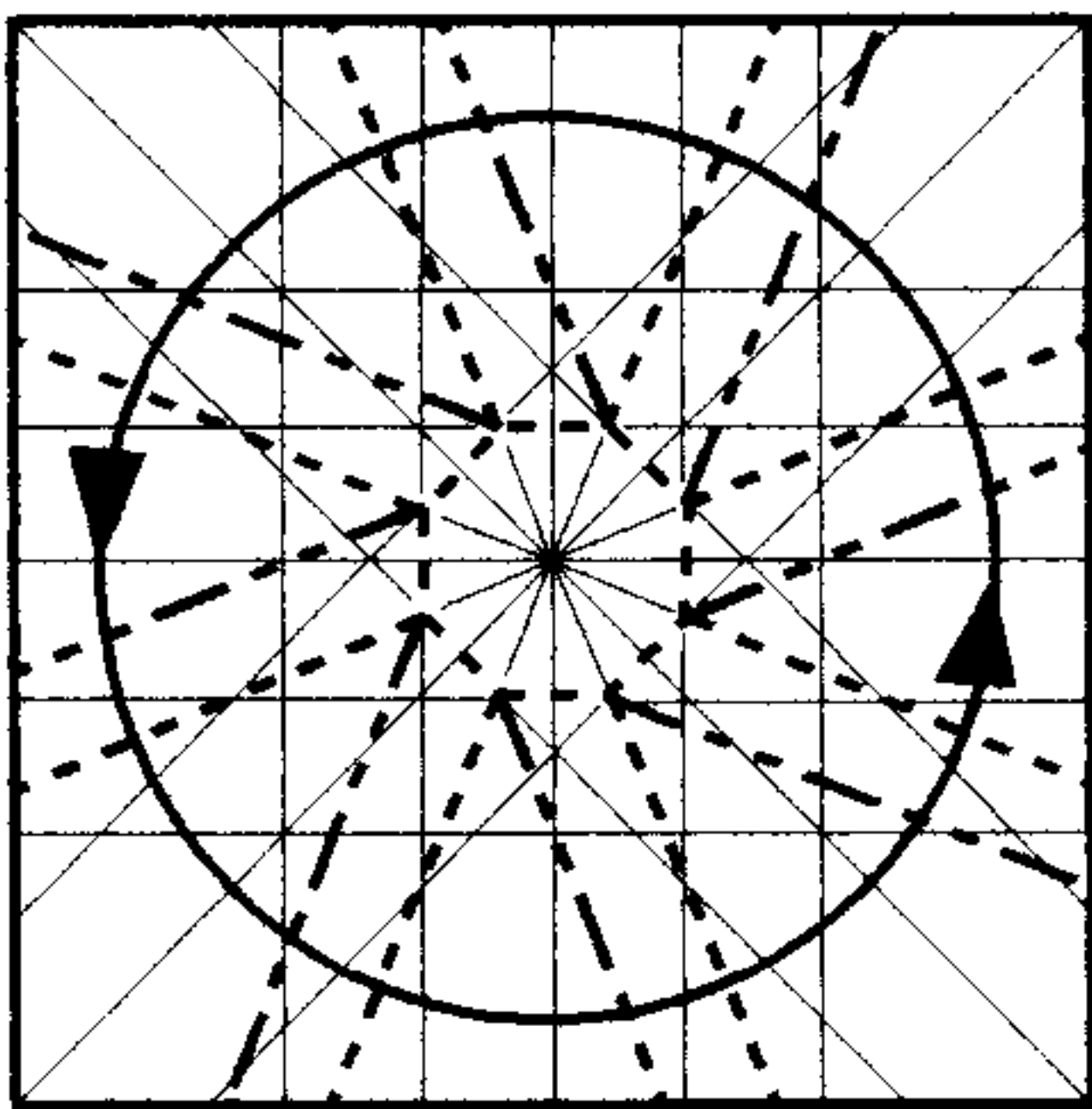

ねじり折りでまとめる

14

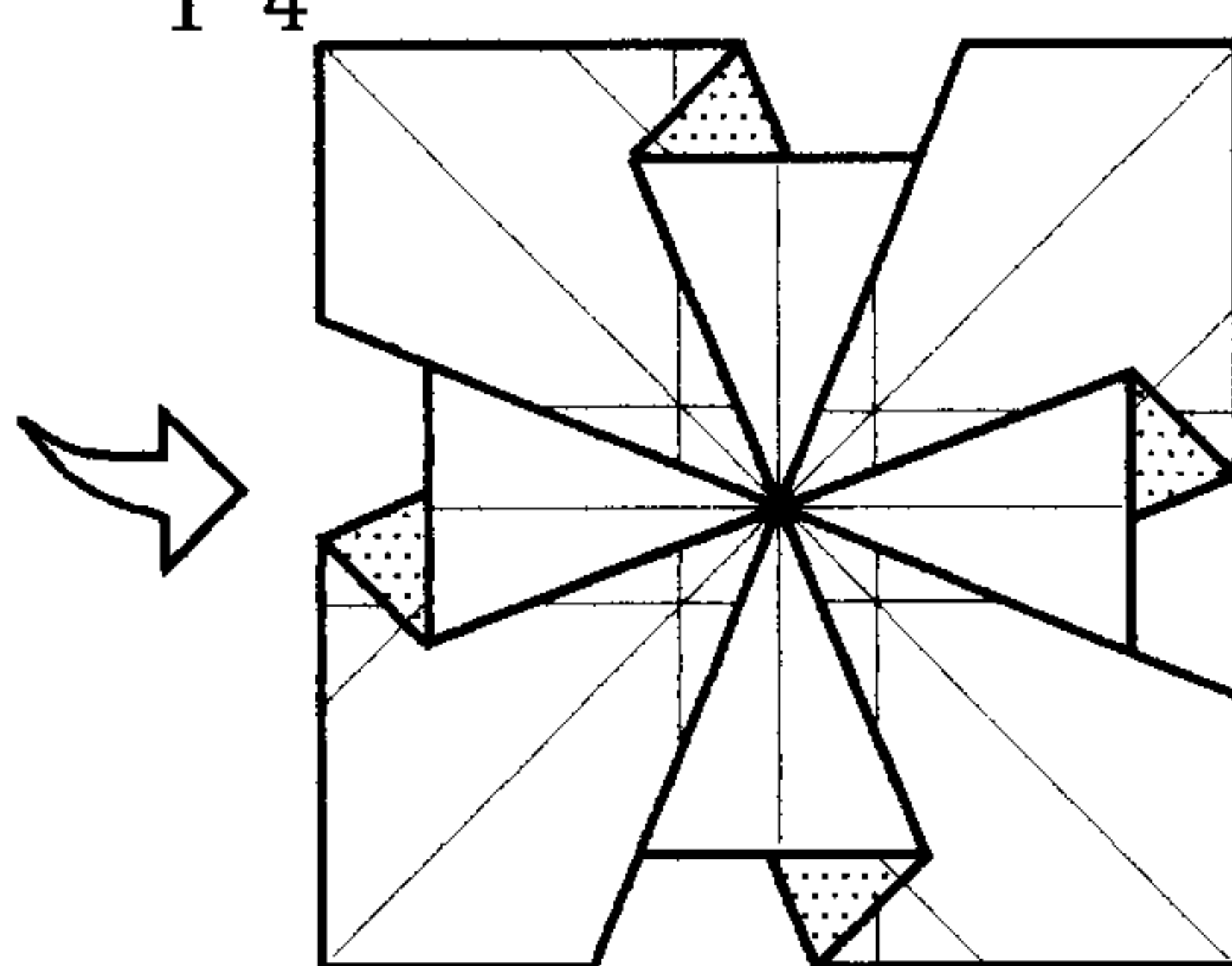

このようになる

15

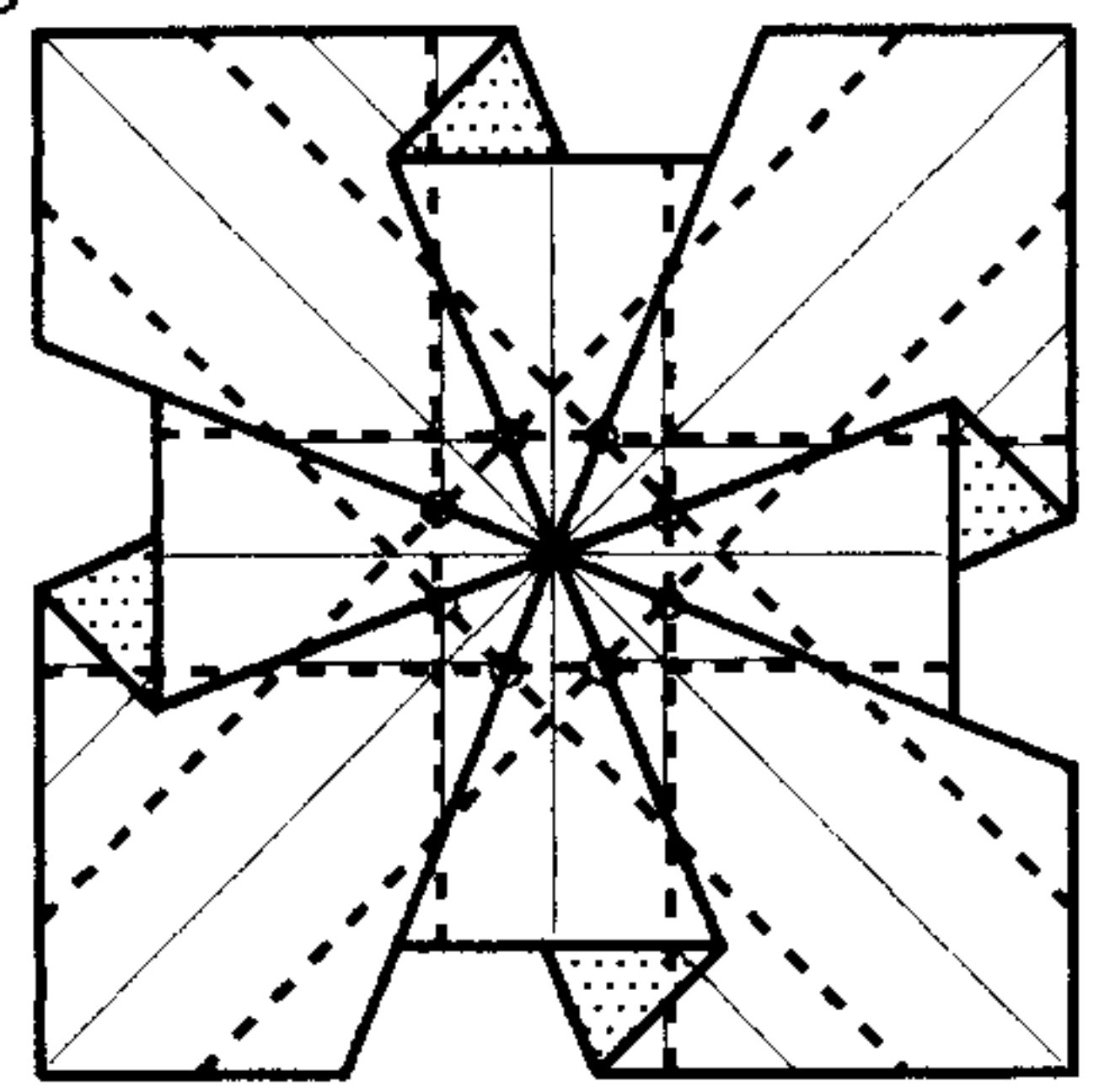

紙を重ねたまま折り目をつける  
但し、裏側にある八角形の部分だけは折らない

1 6

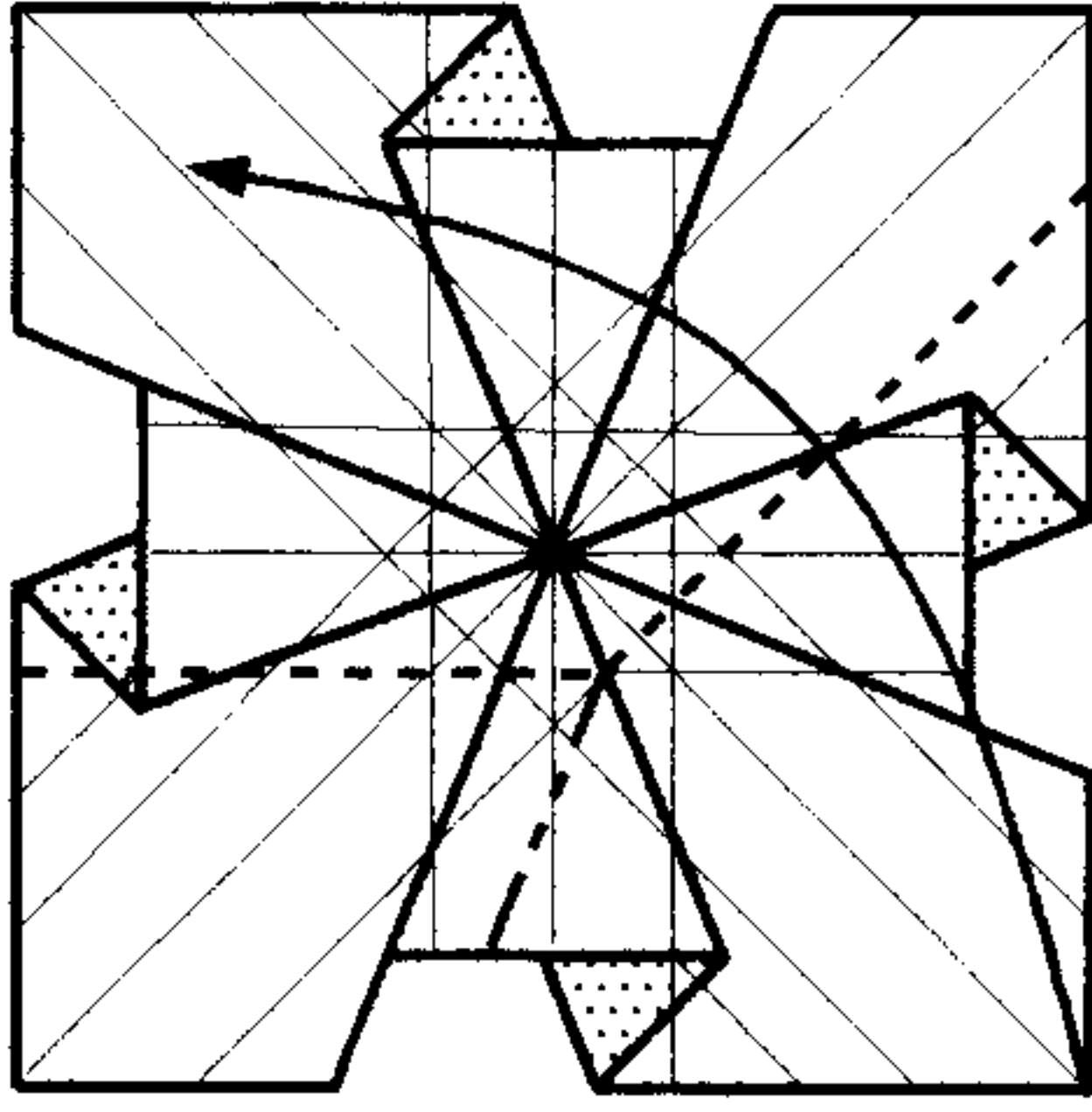

図の谷折り線に沿って折りたたむ（山折り線は折りたたむと自然につく）

1 7

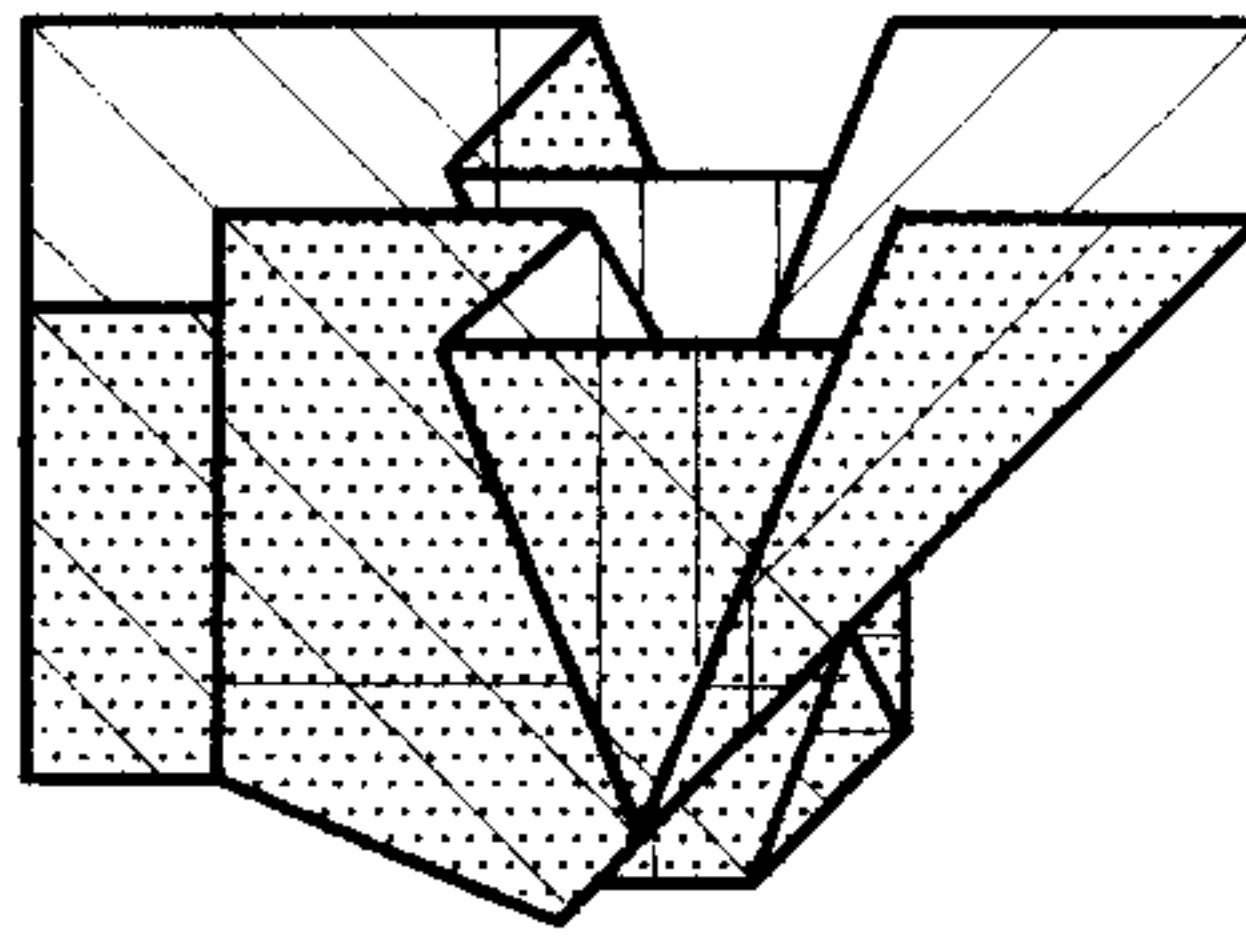

広げる

1 8

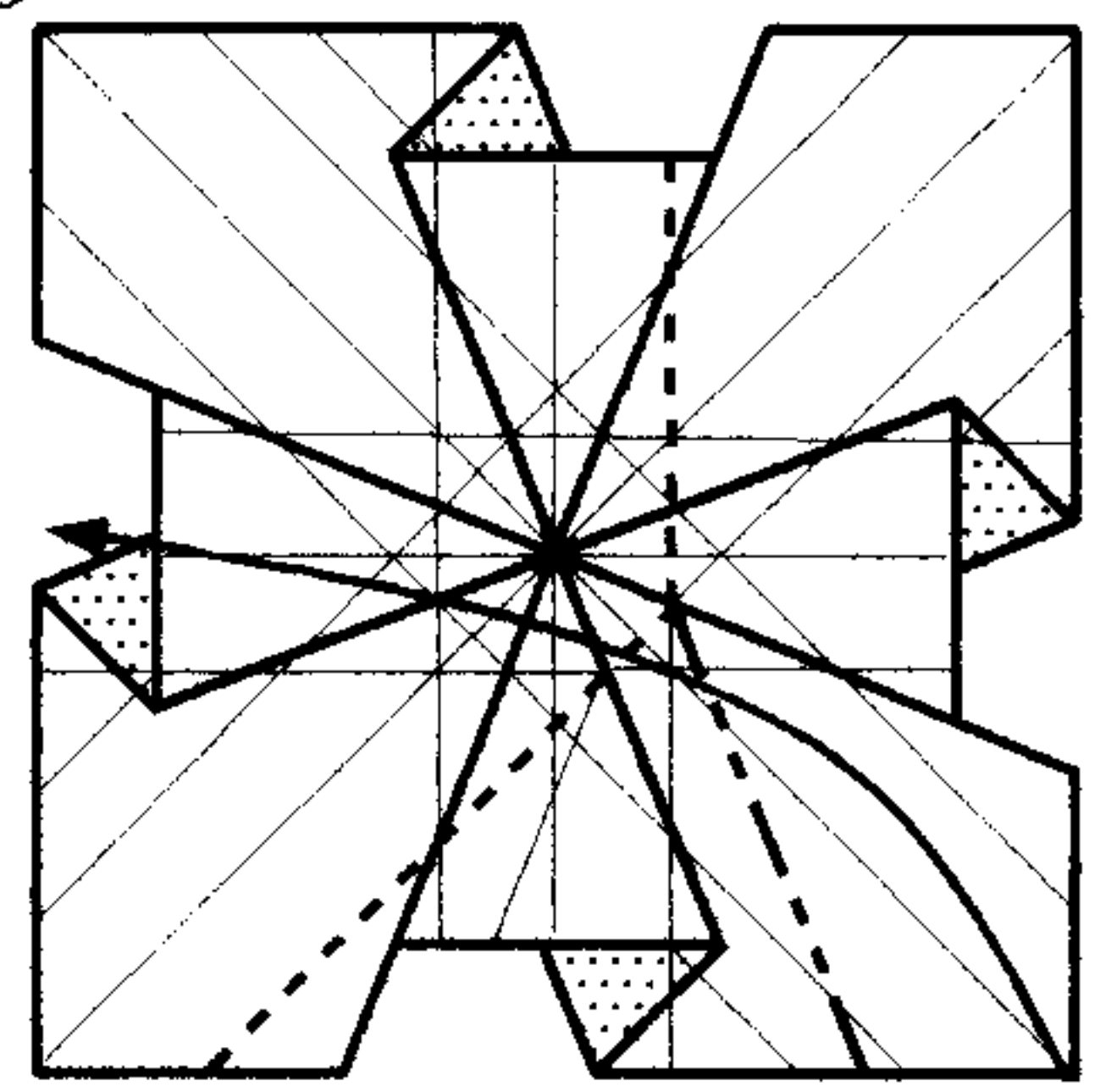

図の谷折り線に沿って折りたたむ（山折り線は折りたたむと自然につく）

1 9

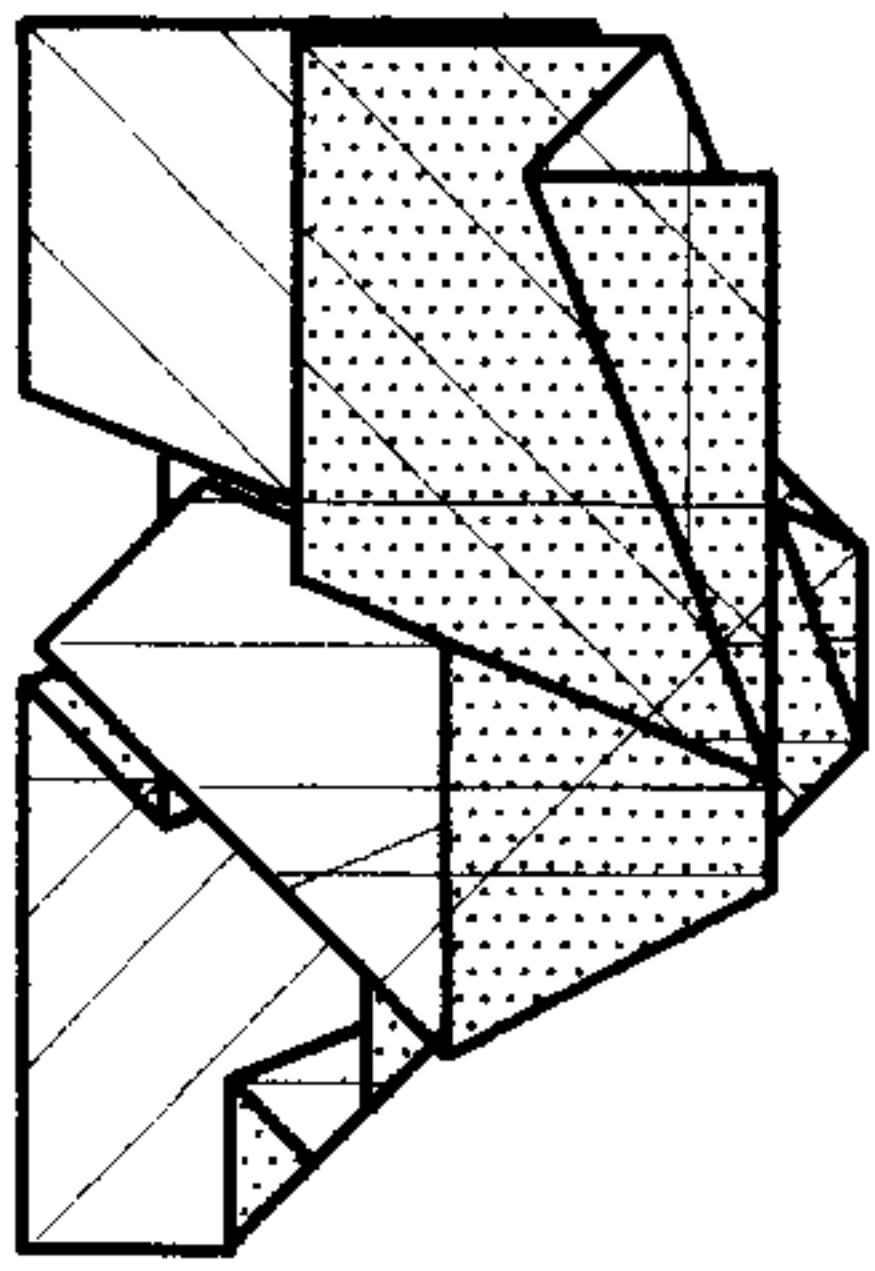

広げる

2 0

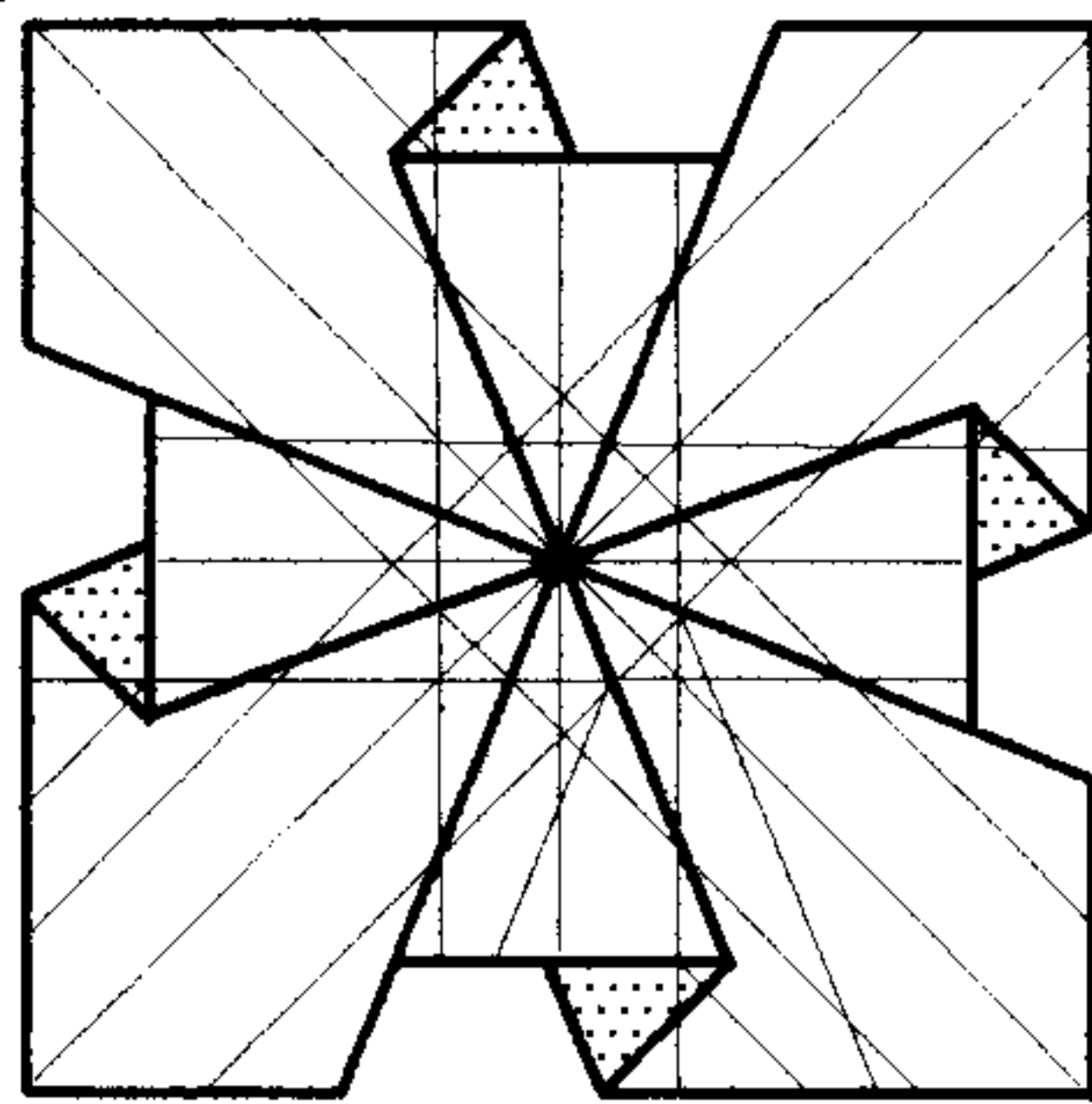

他の3辺も16～19と同様に折る

2 1

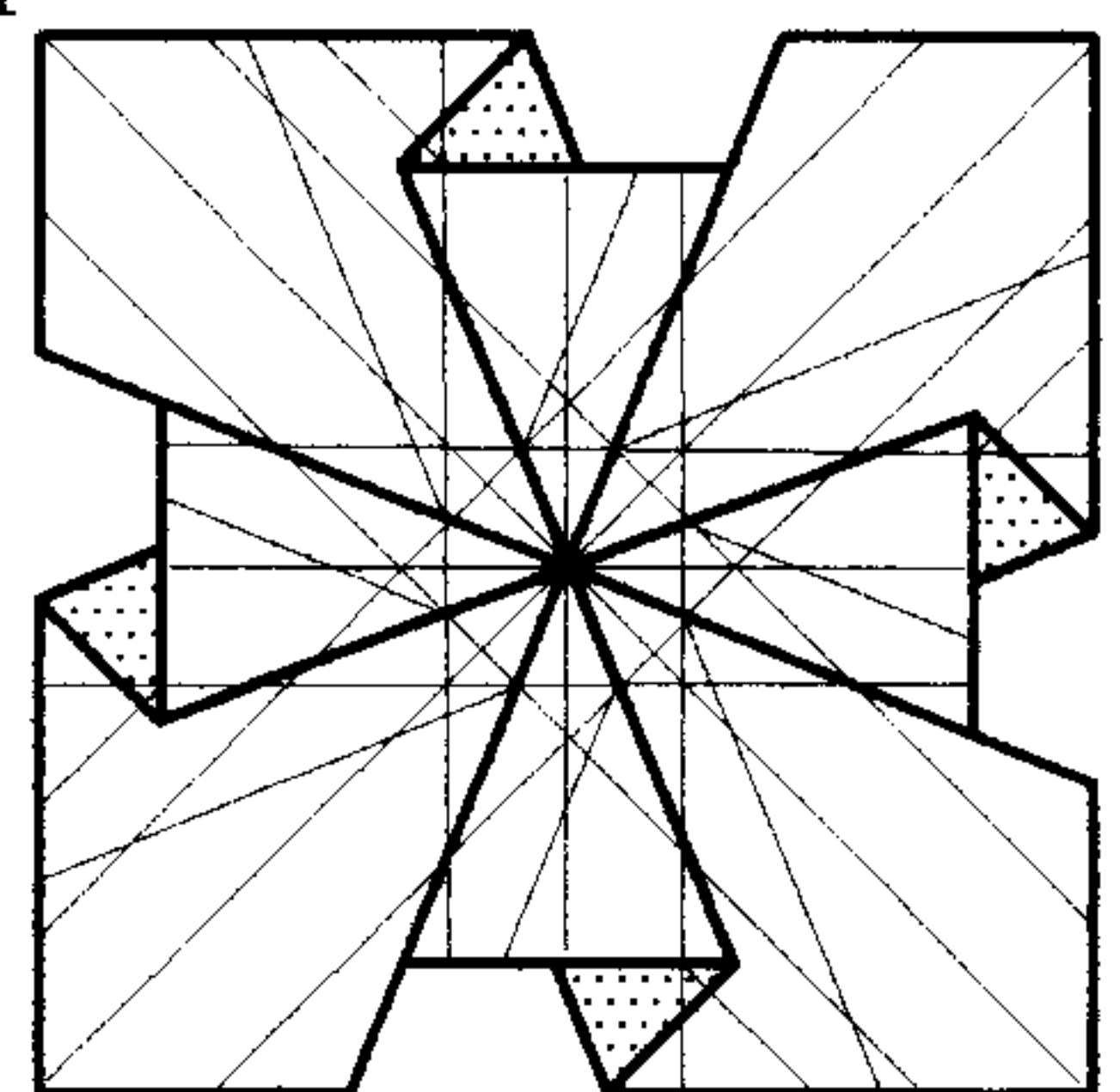

折り目つけ終了

2 2

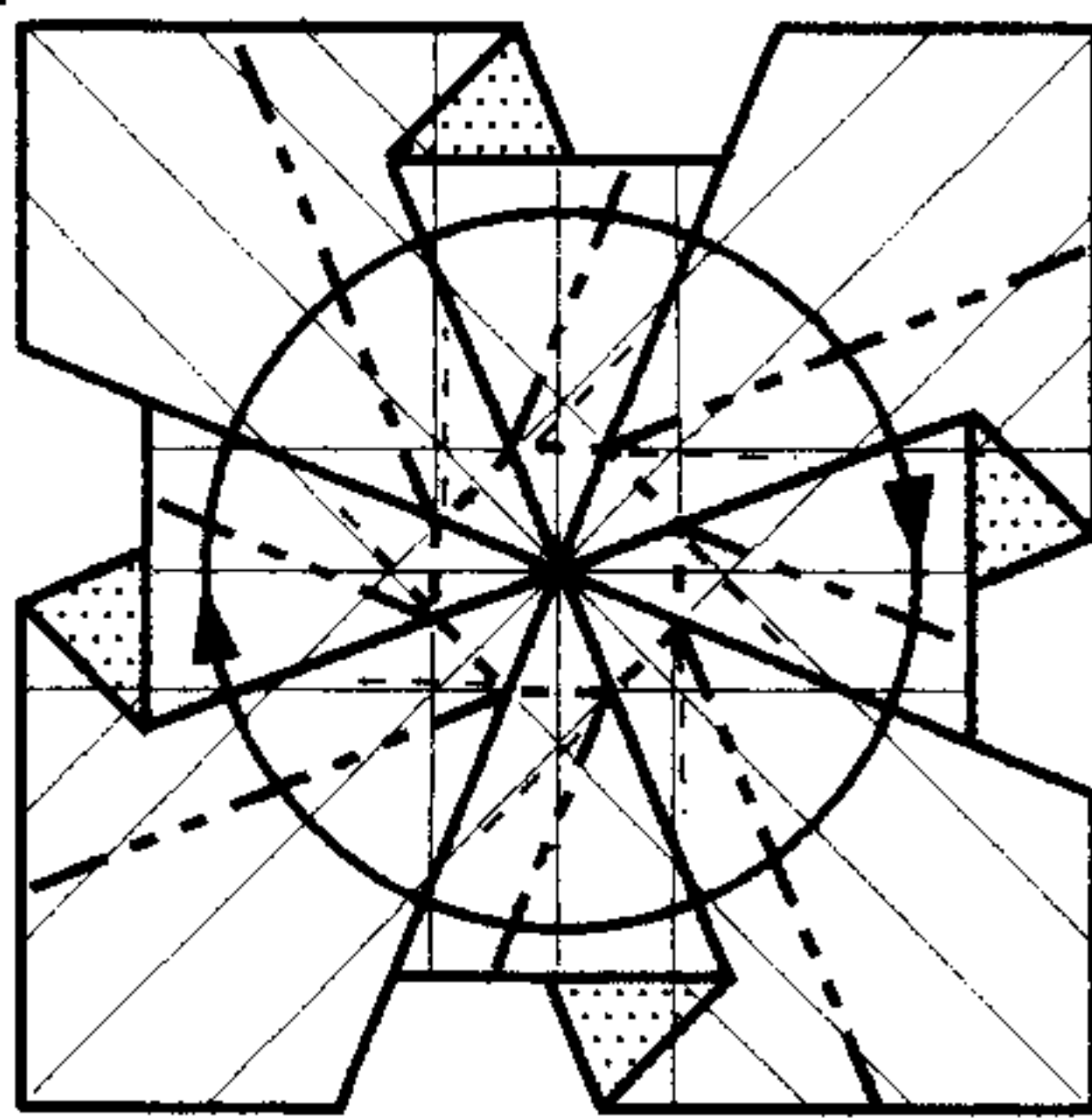

ねじり折りでまとめる

2 3

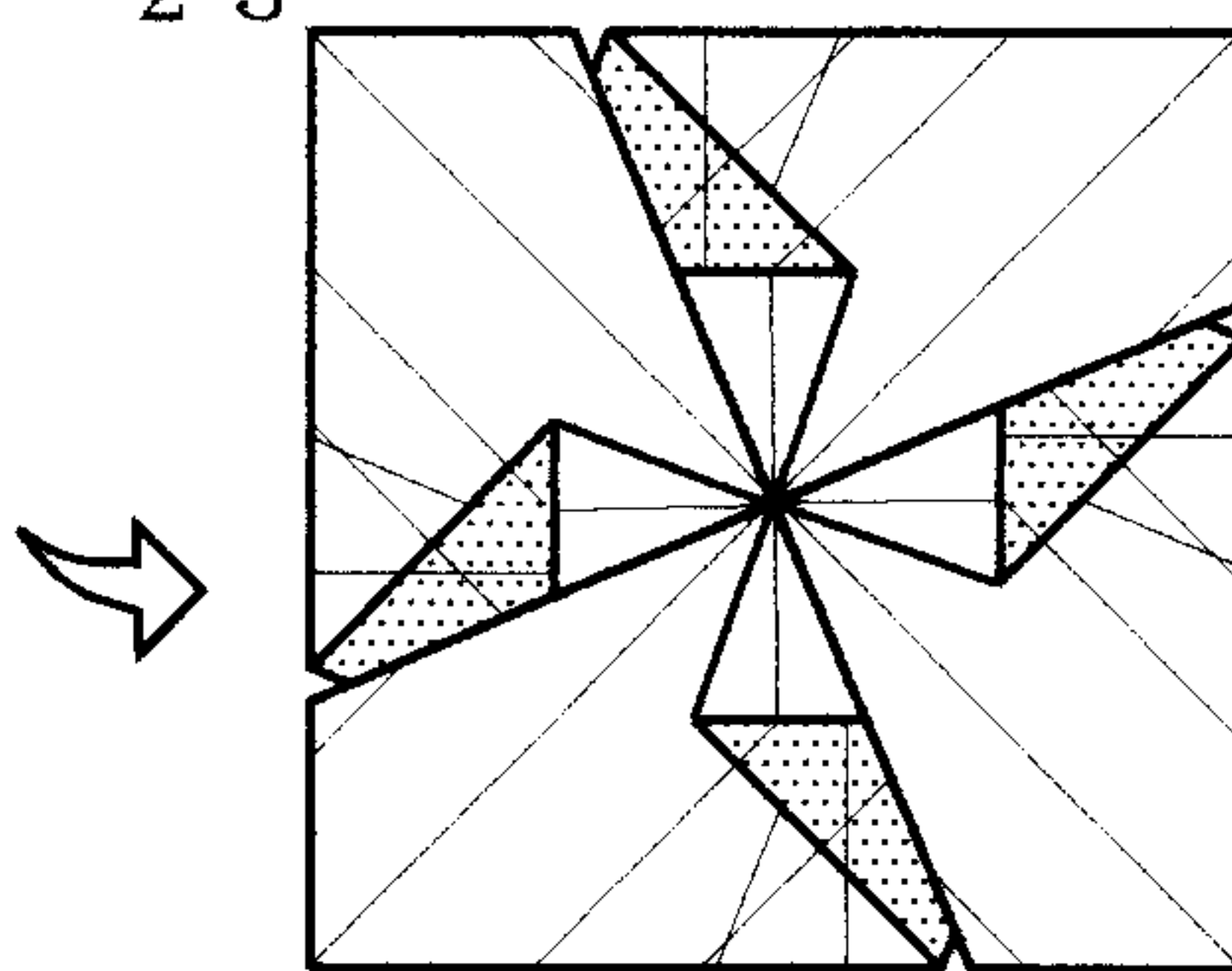

このようになる

2 4

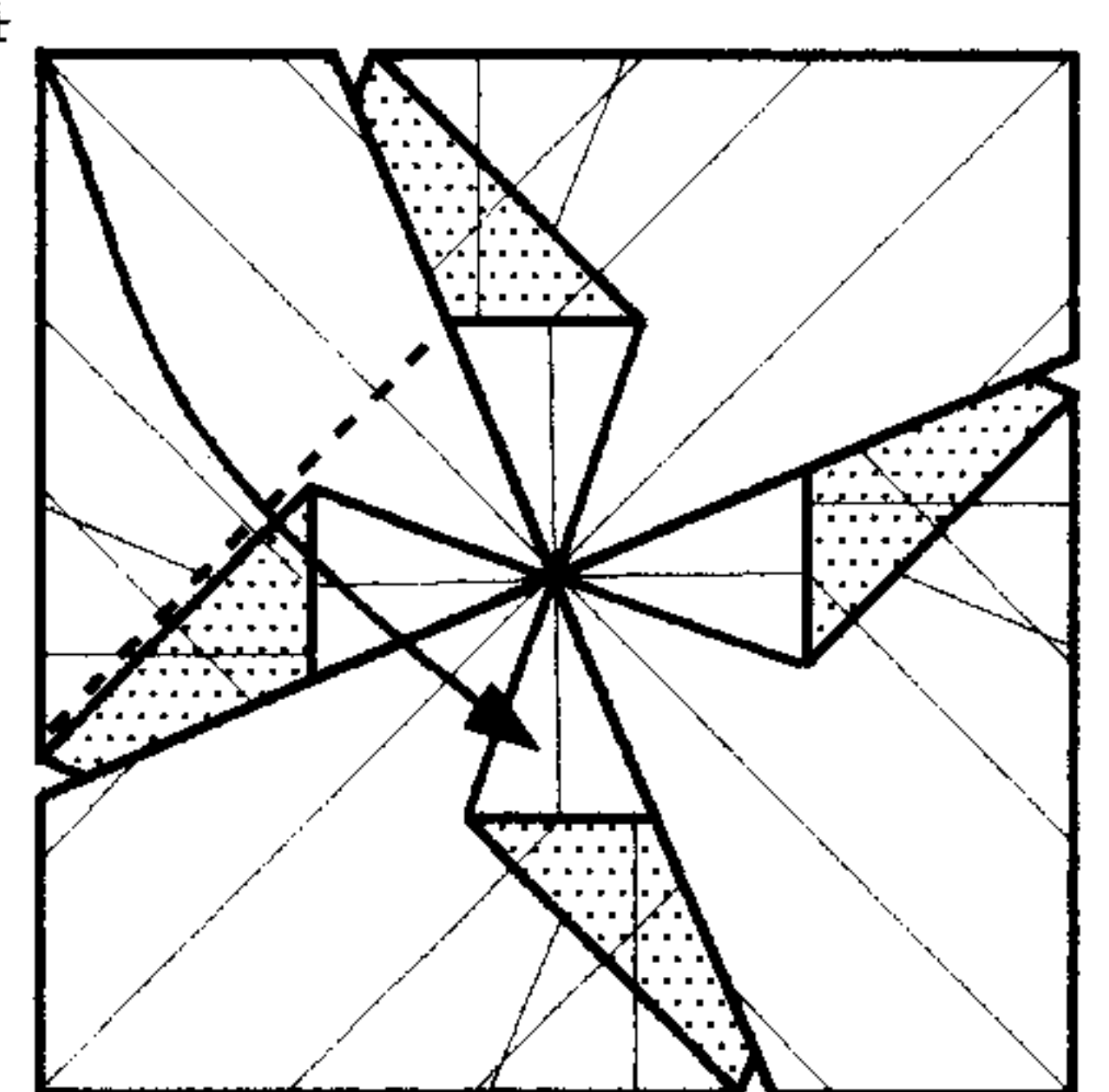

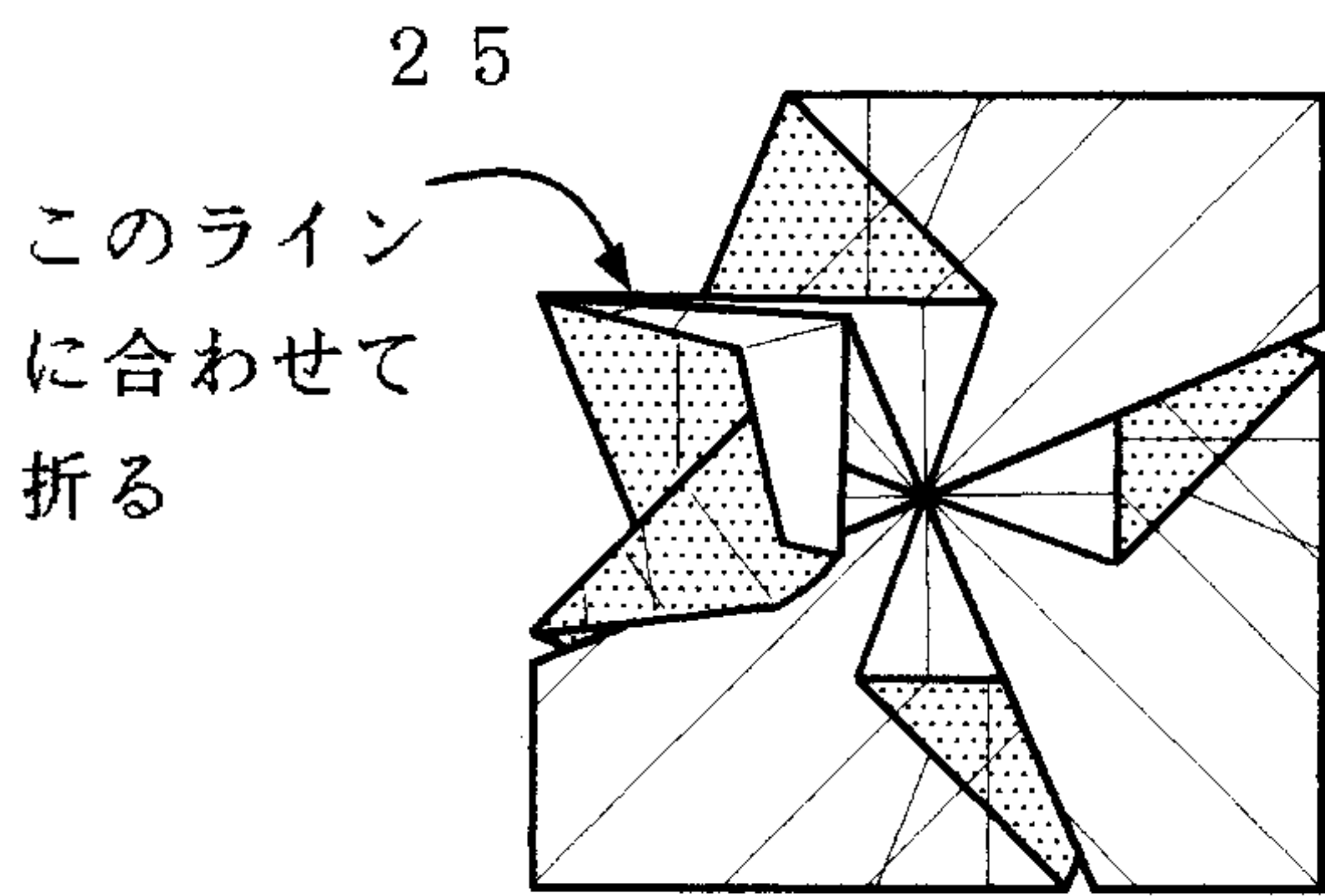

途中図

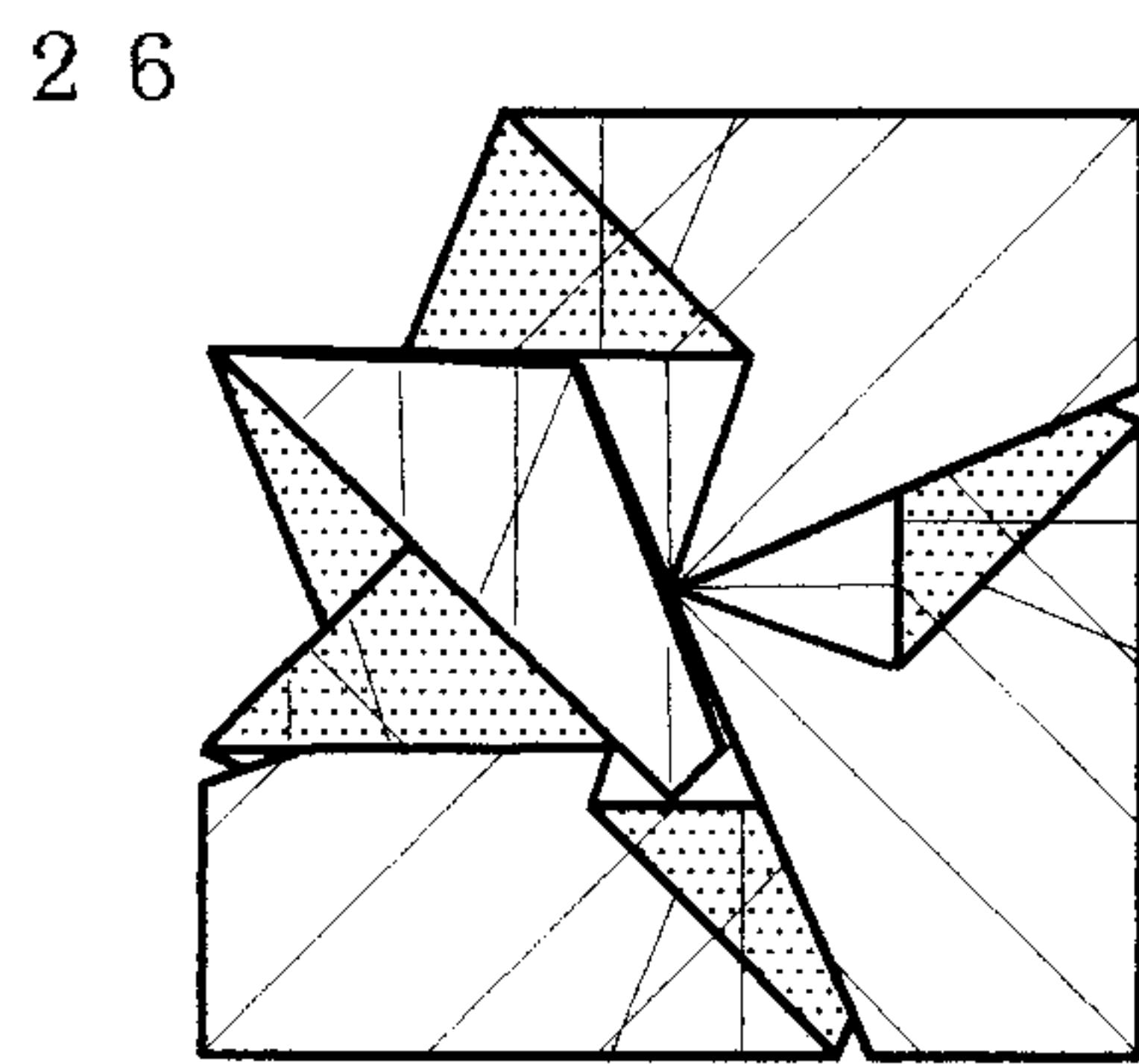

他の3つの角も24~25と同様に折る  
中央部で組む

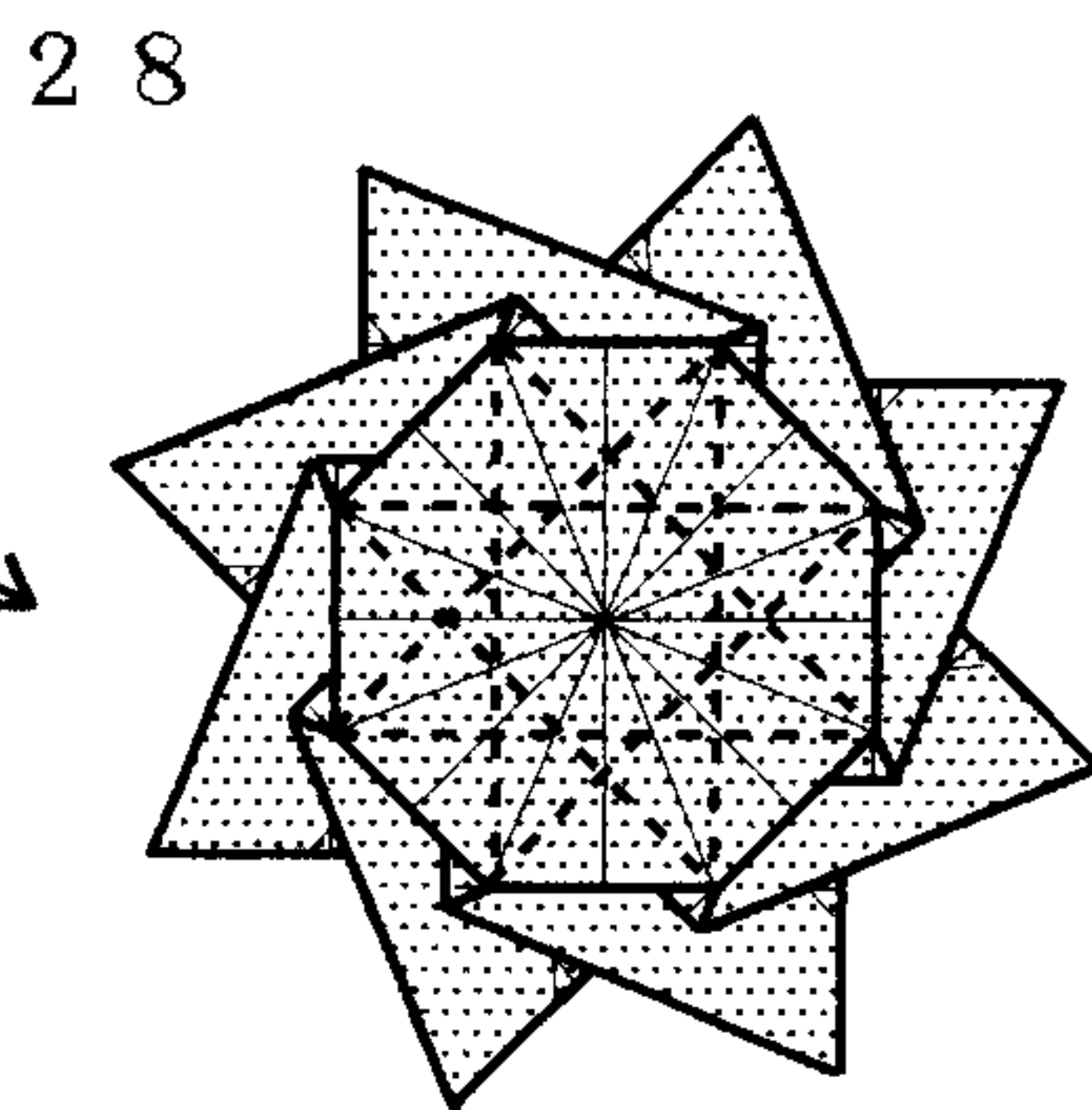
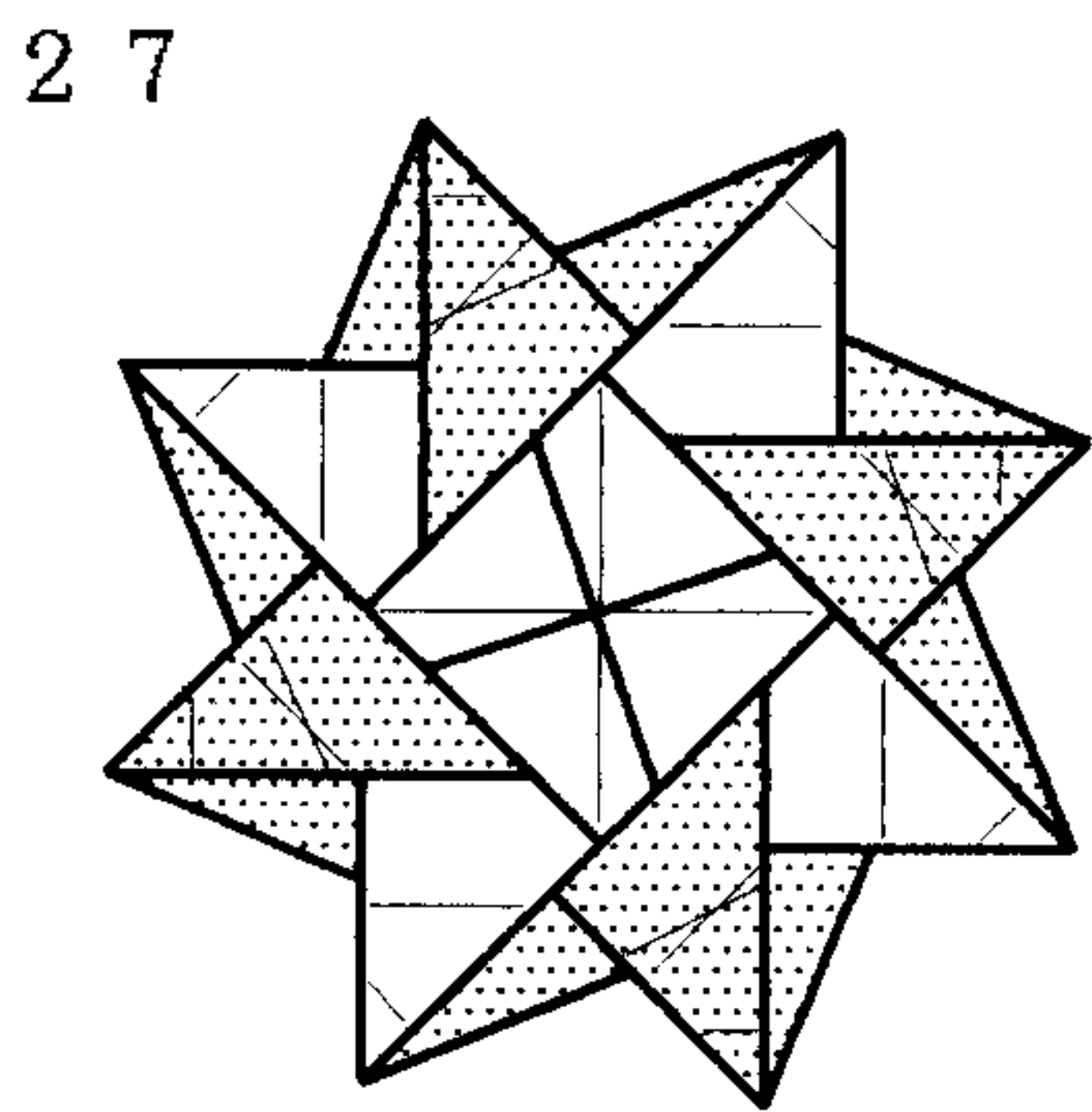

折り目をつける

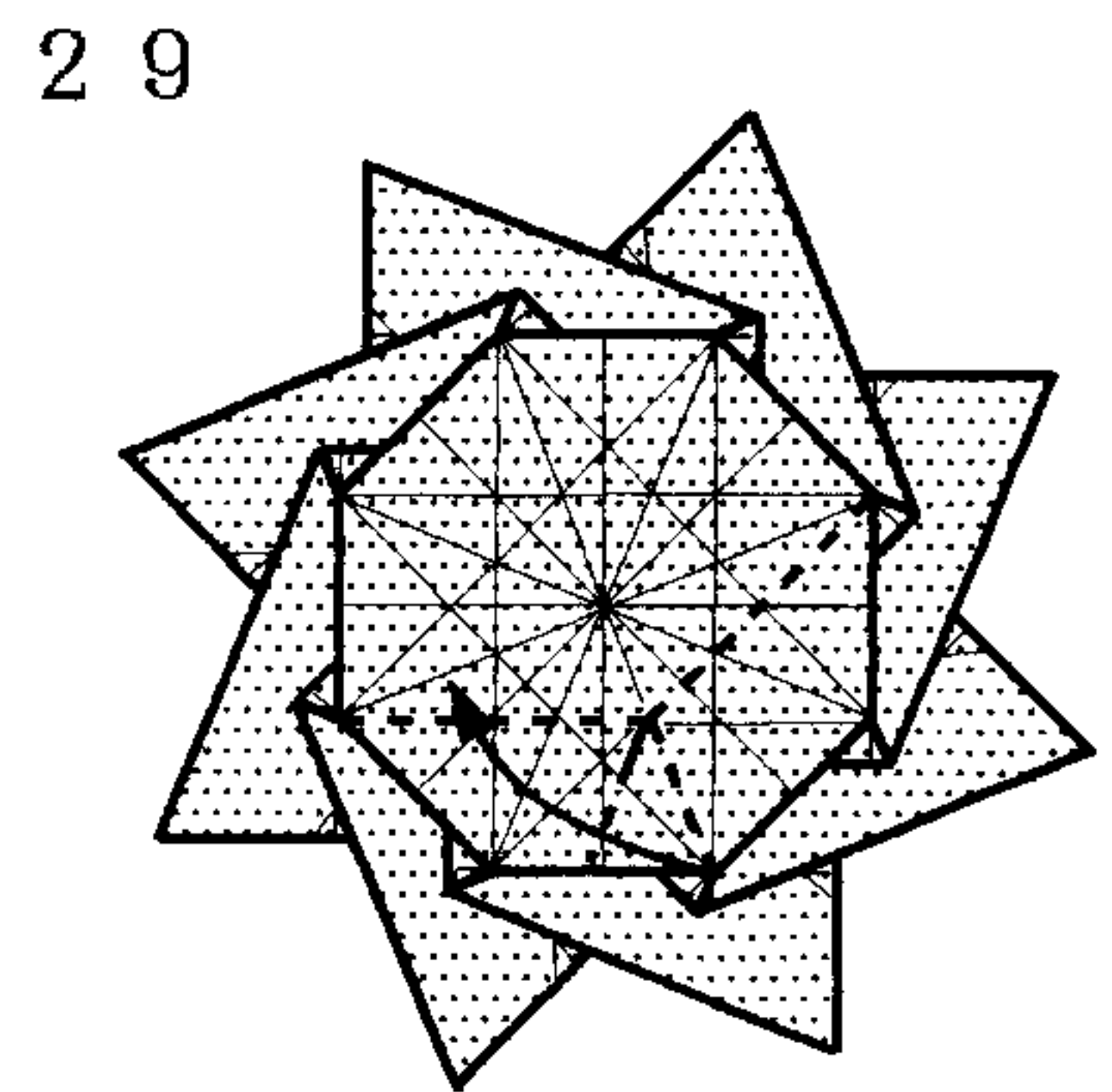

図の谷折り線に沿って折りたたむ（山折り線は折りたたむと自然につく）

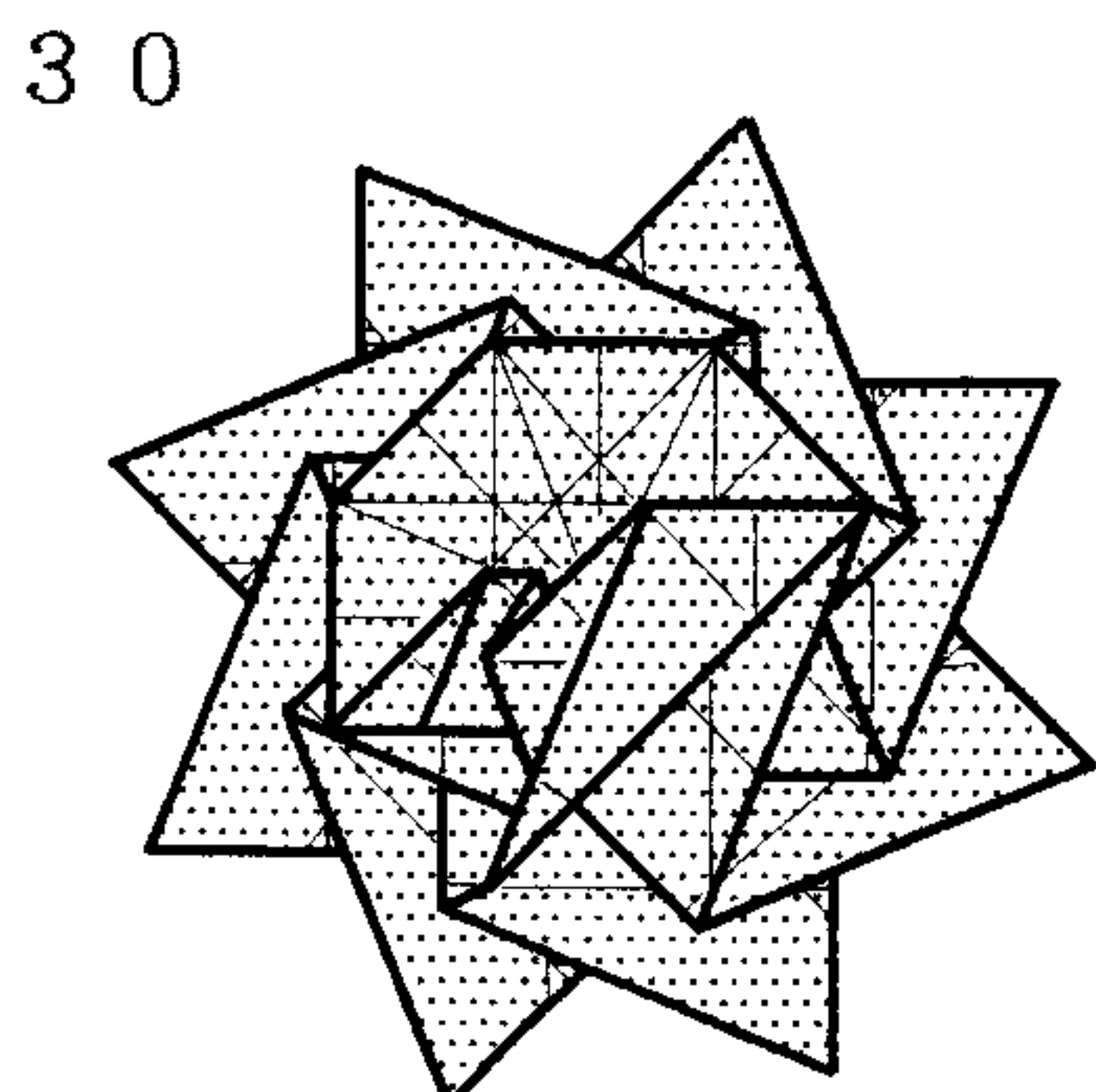

広げる

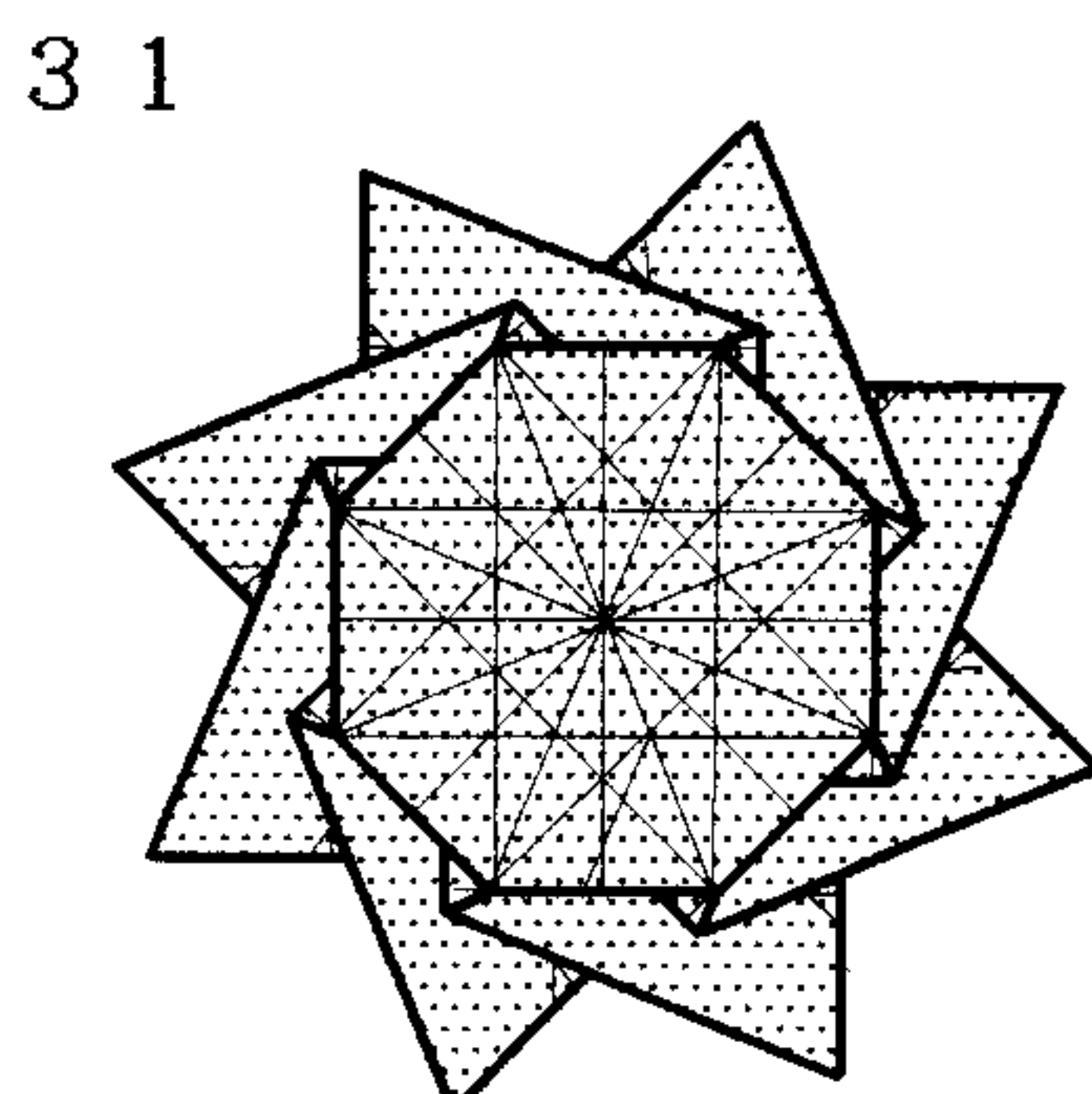

他の7辺も29~30と同様に折る

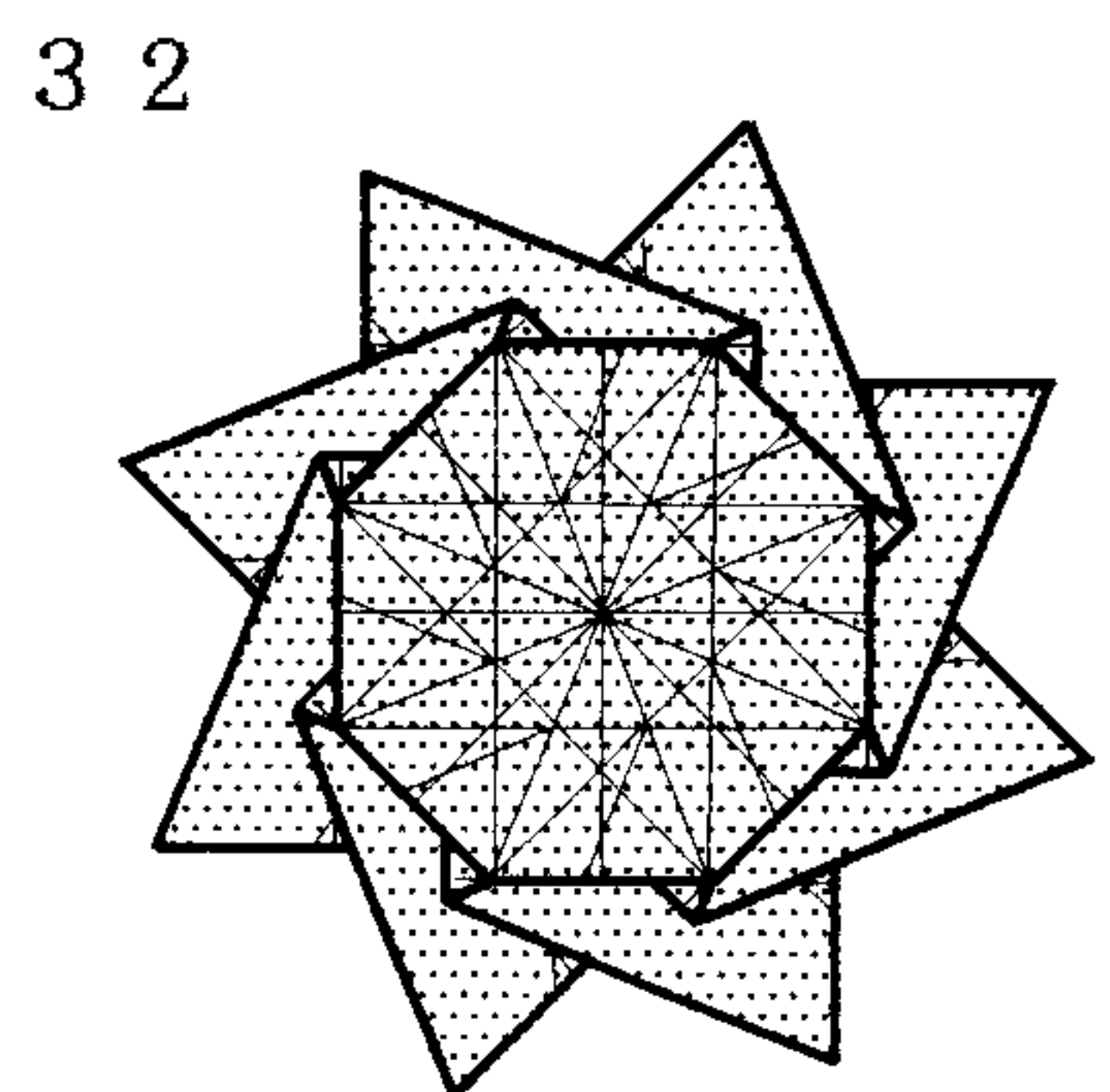

折り目つけ終了

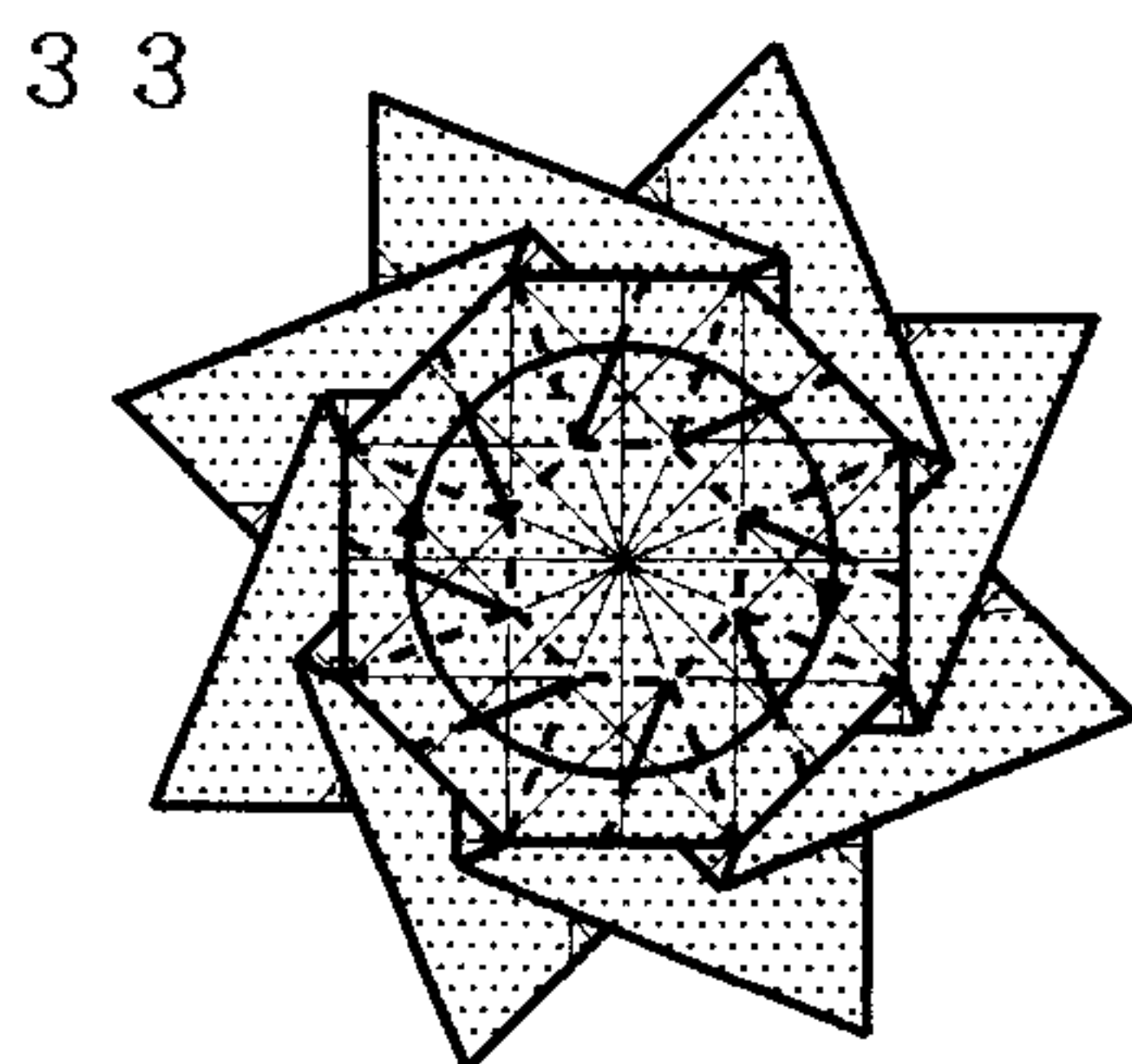

ねじり折りでまとめる  
中央で組む

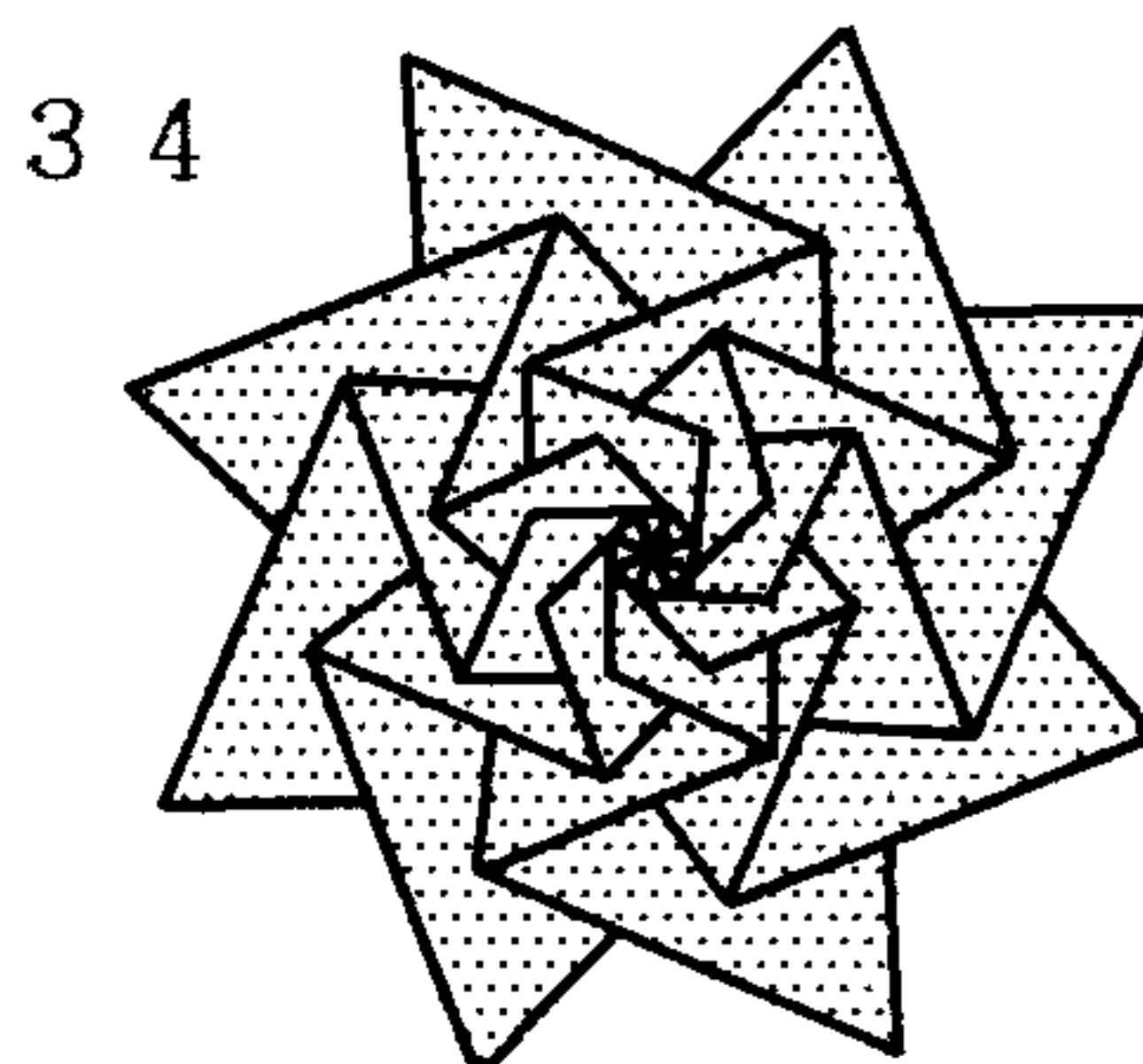

できあがり