

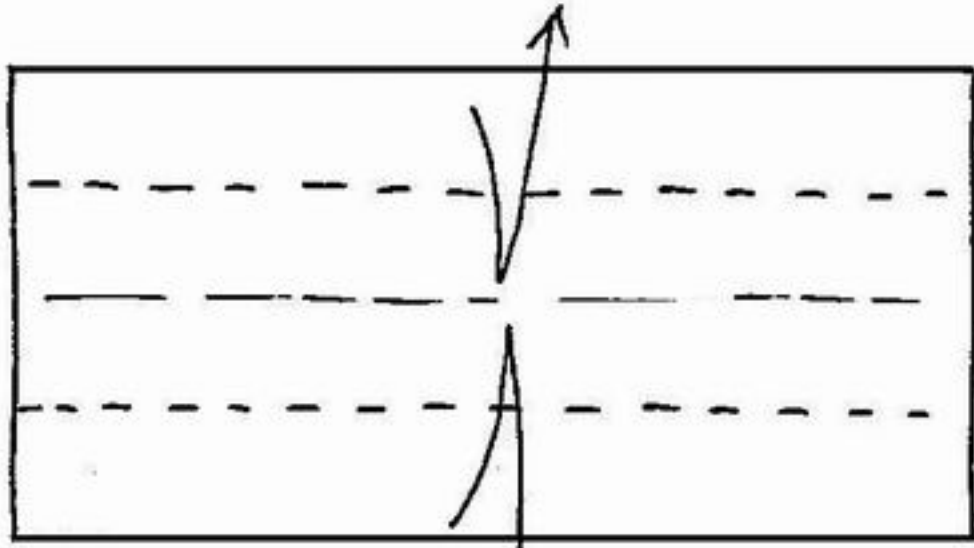



# STAR MEDAL



1 2x1 Rectangle.  
White side up.

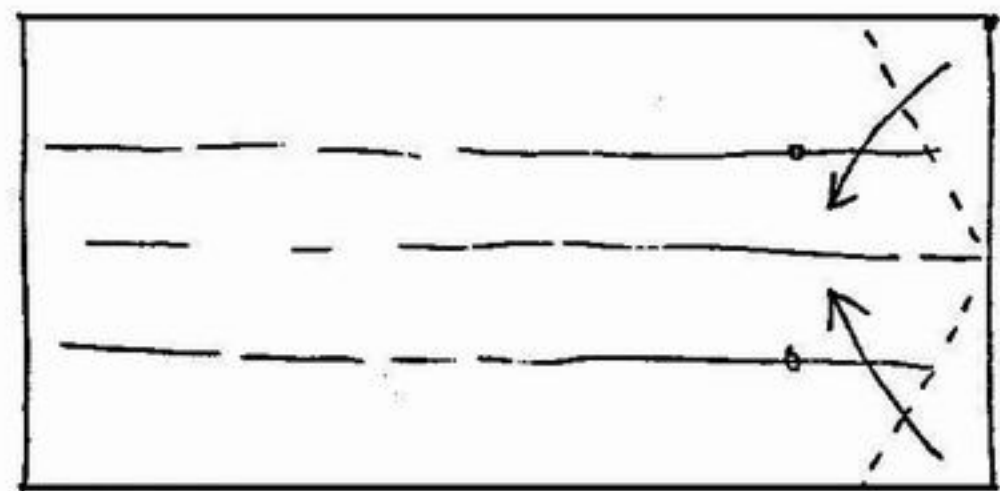

2

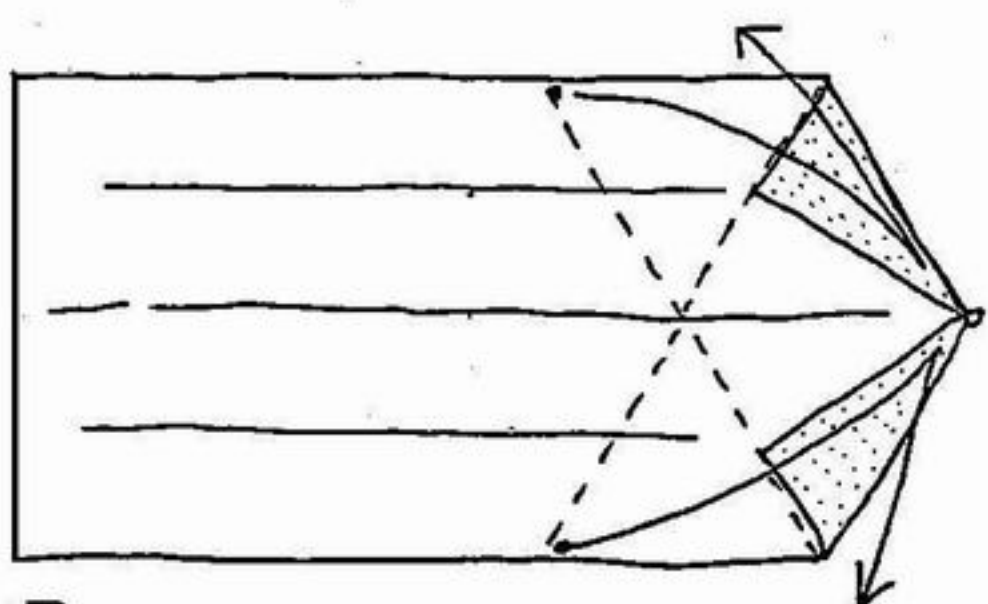

3

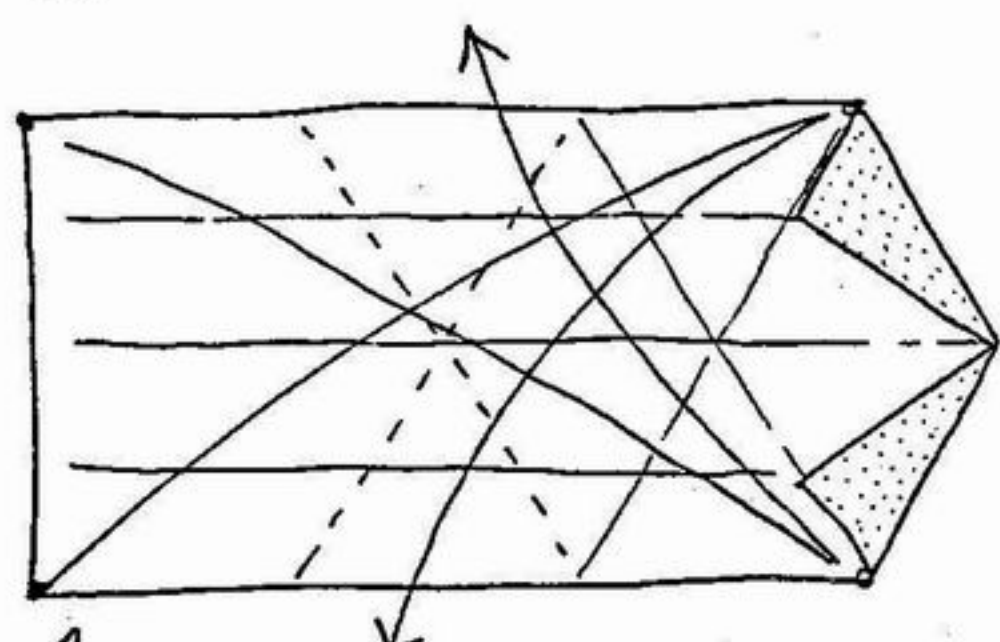

4

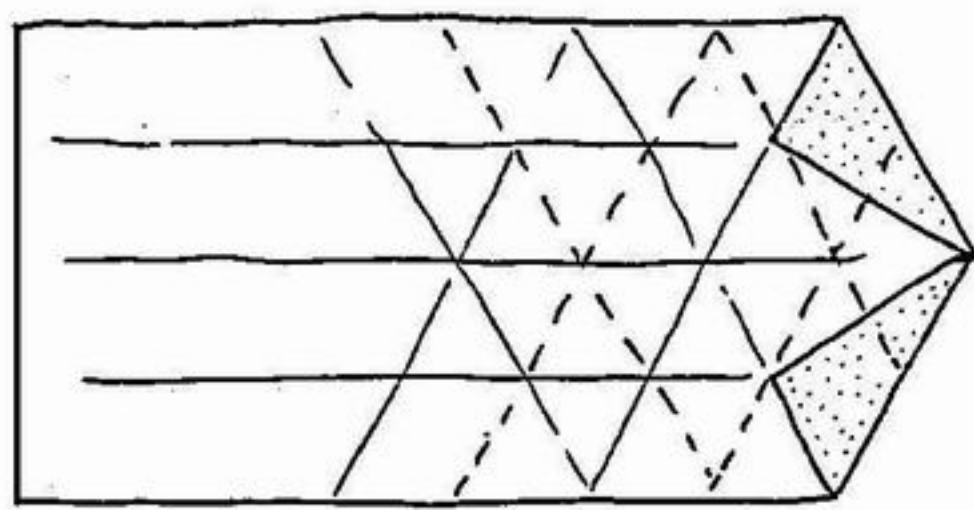

5 Add in creases.

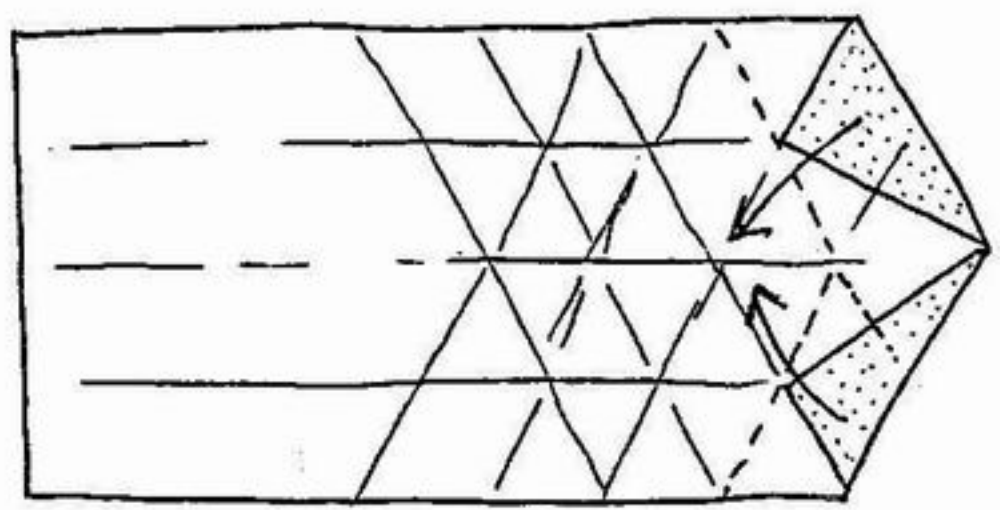

6

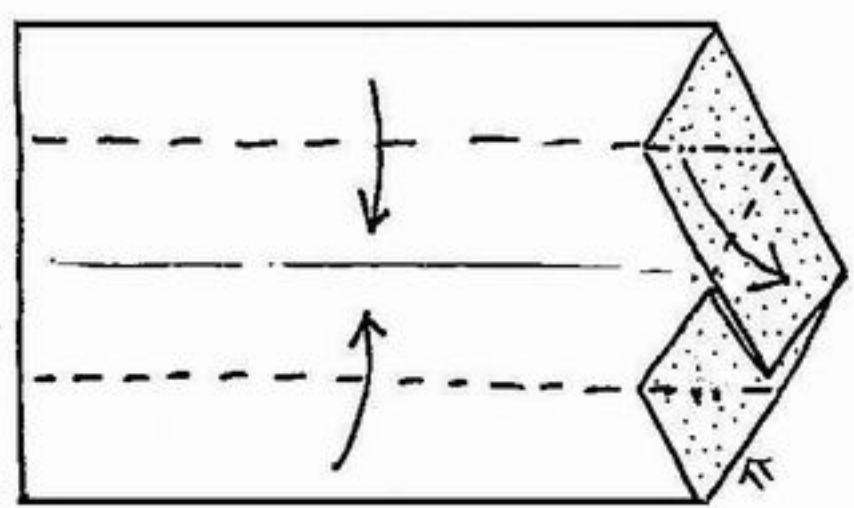

7

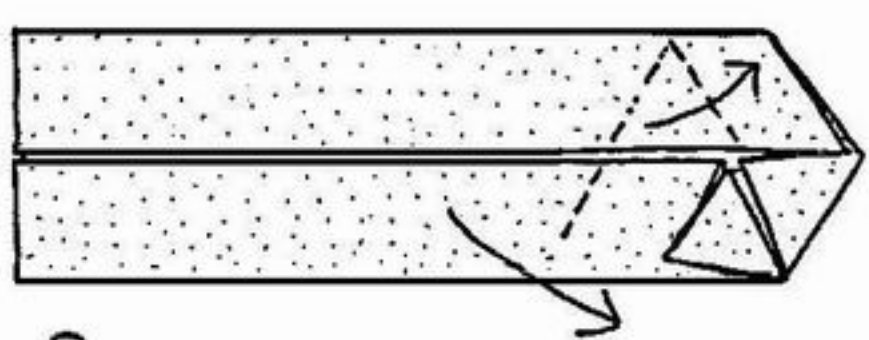

8



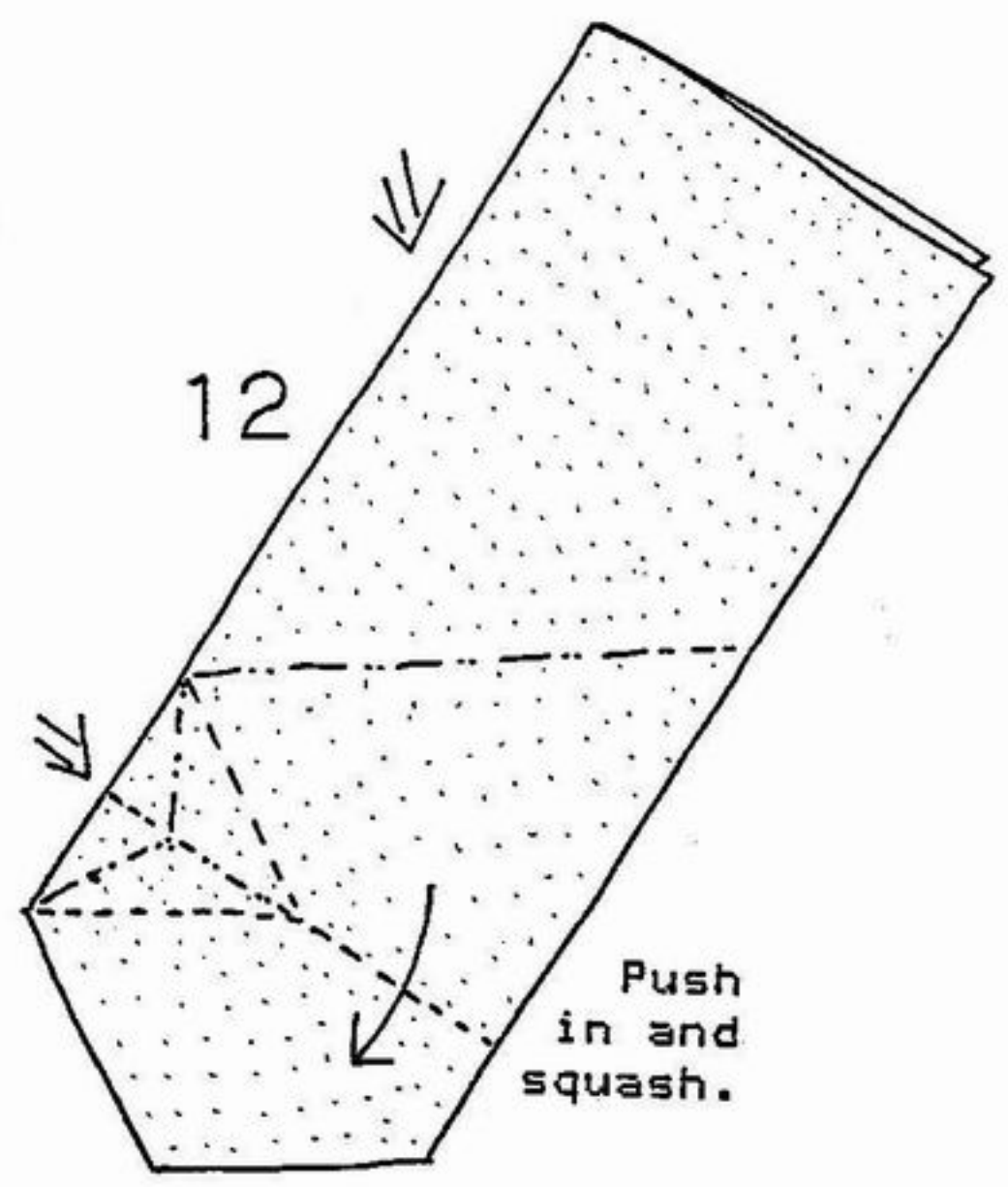
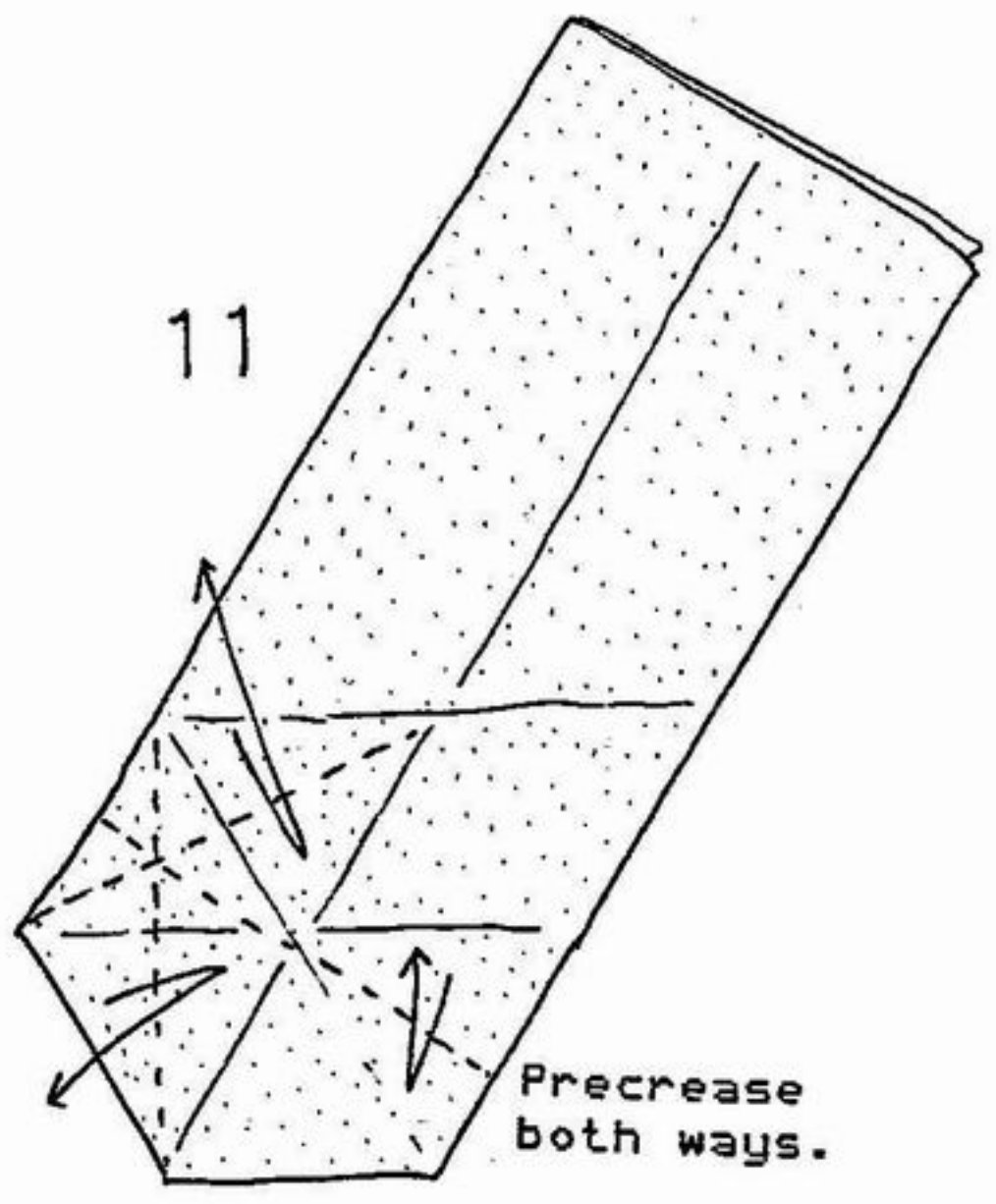
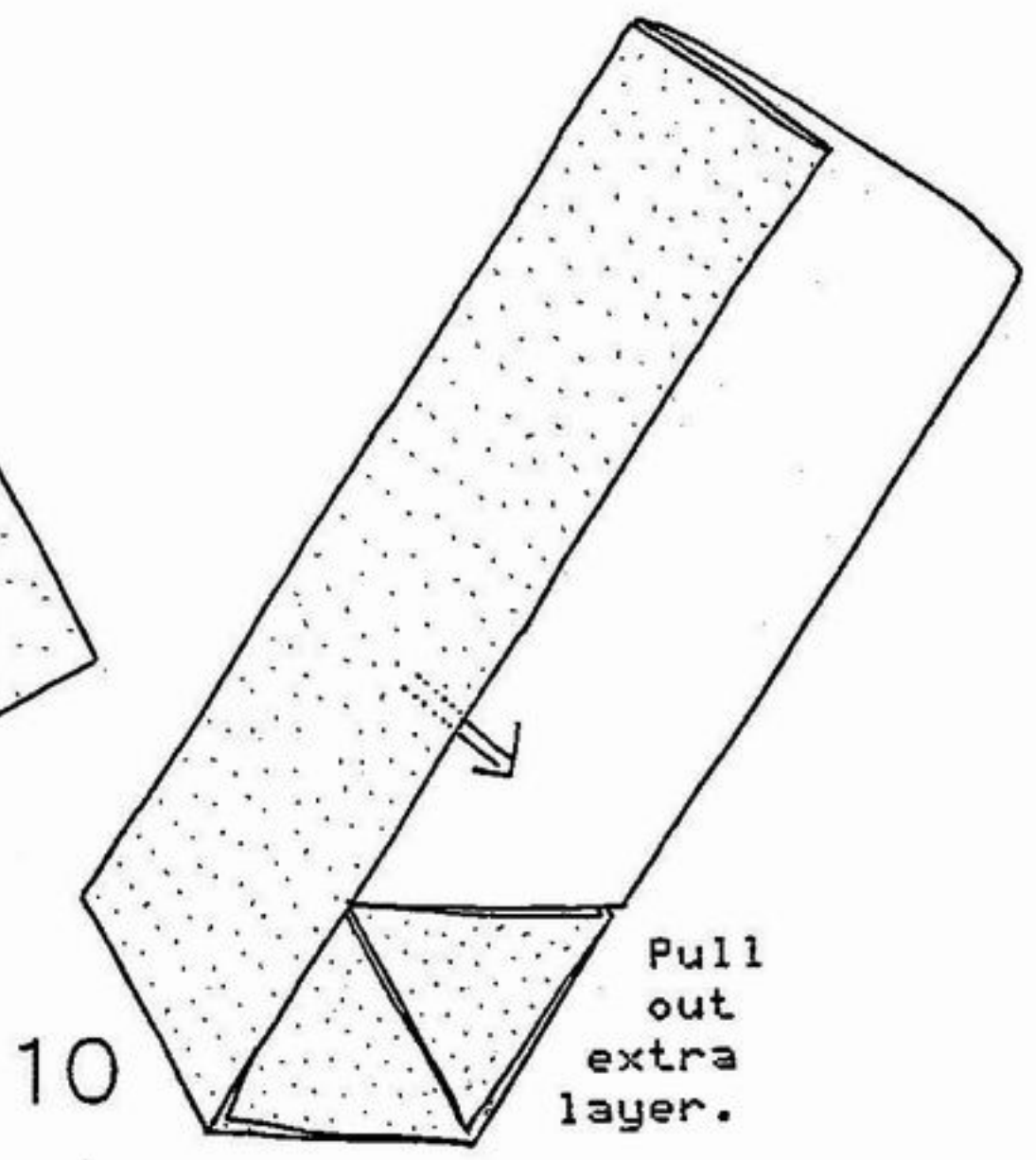
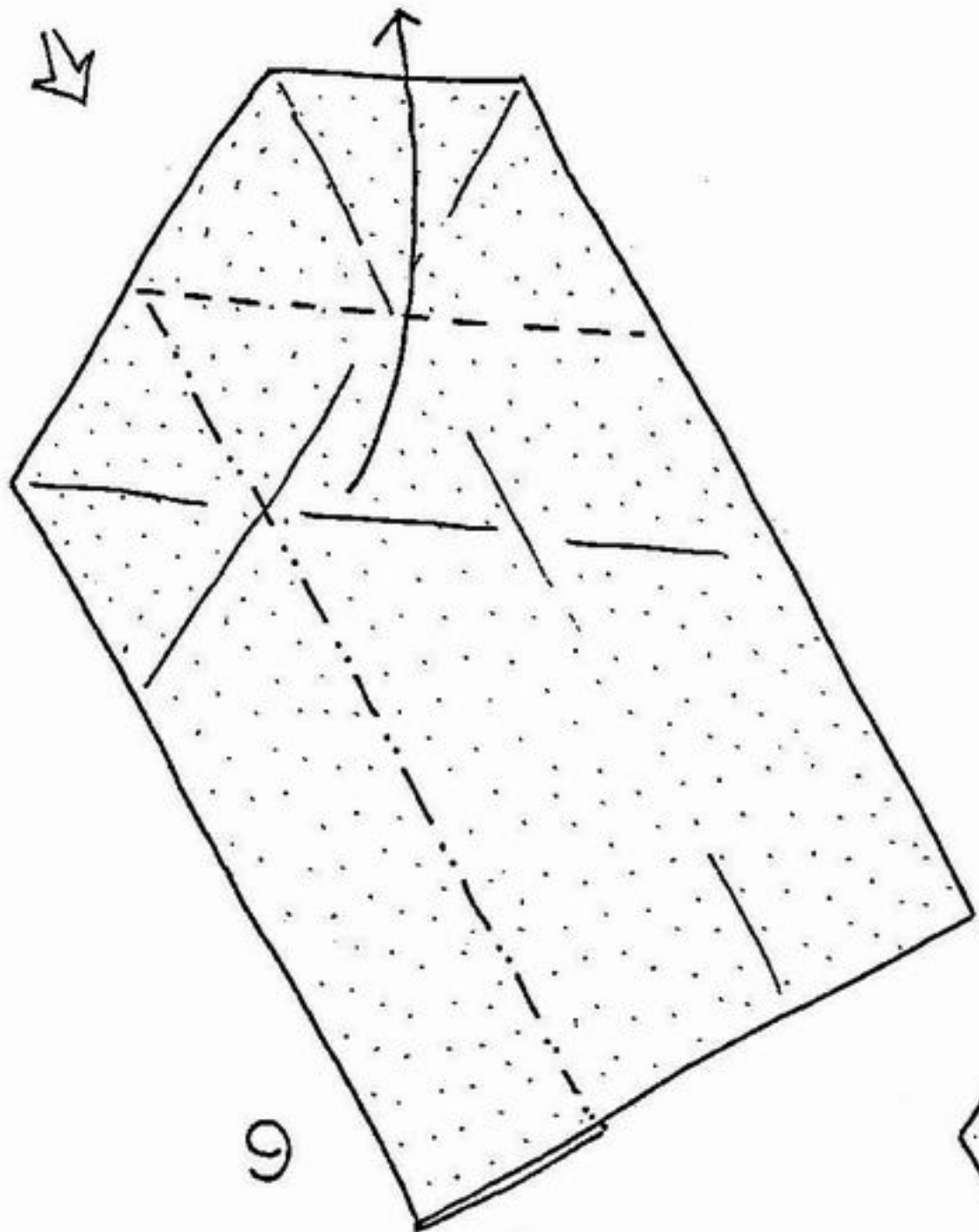



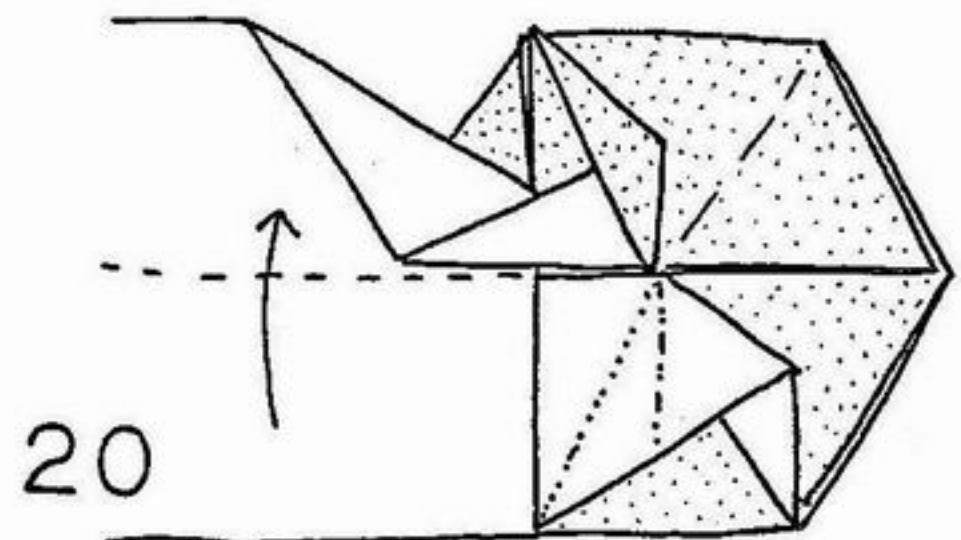
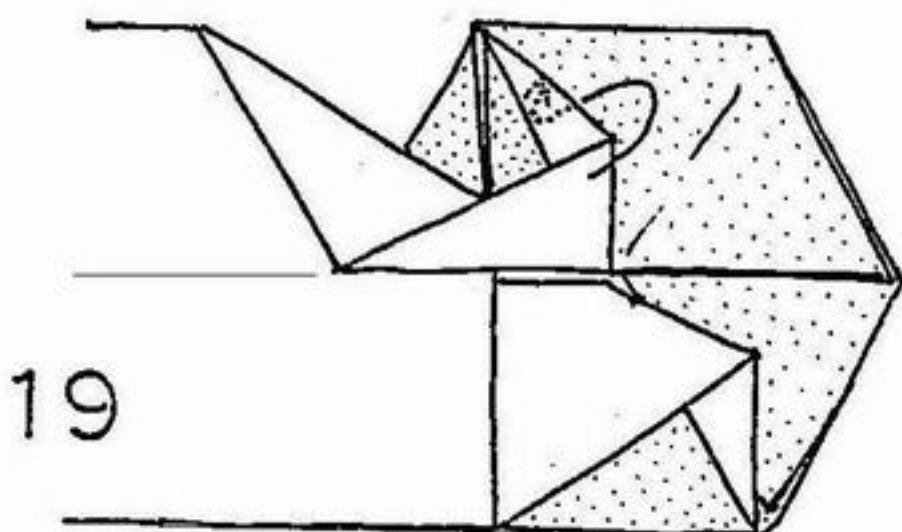
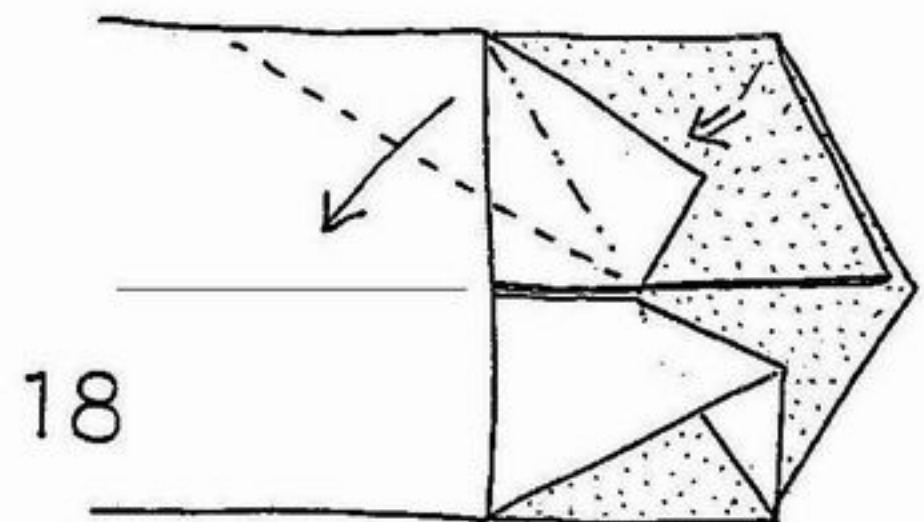
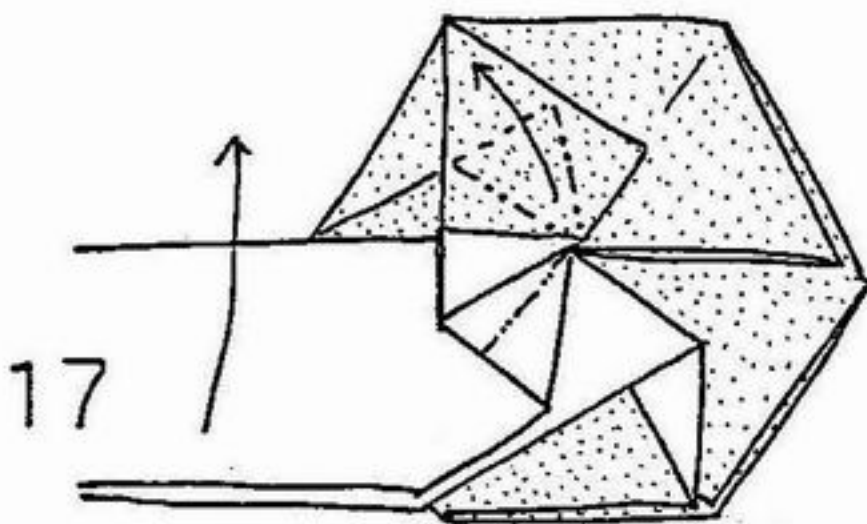
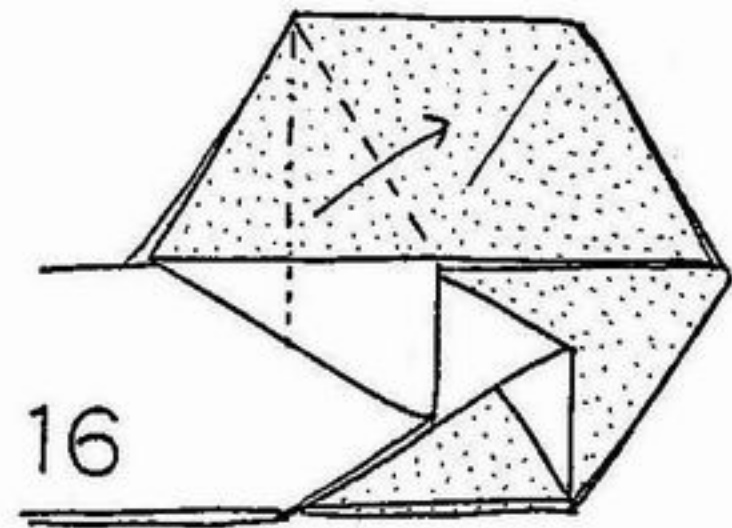
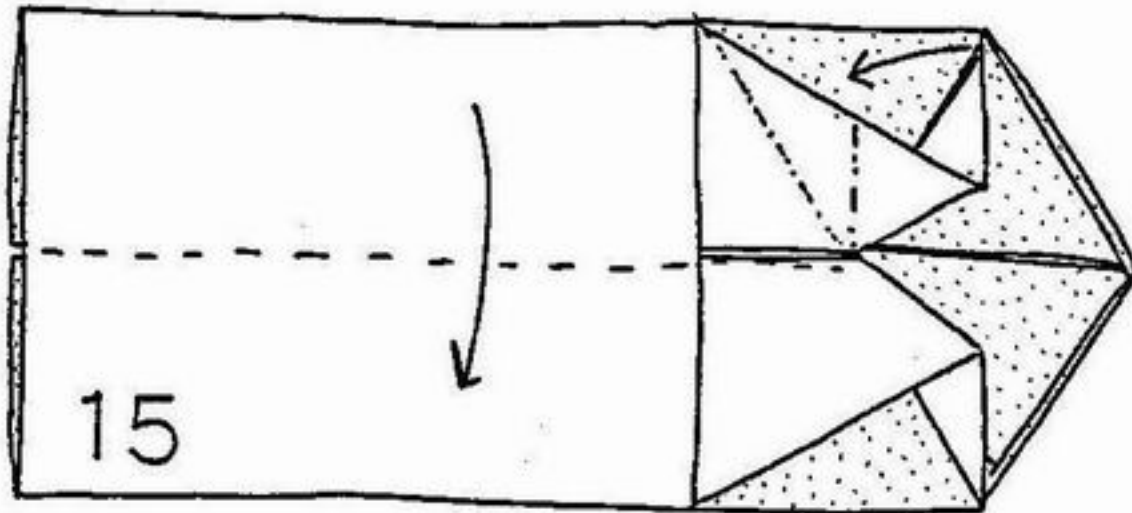
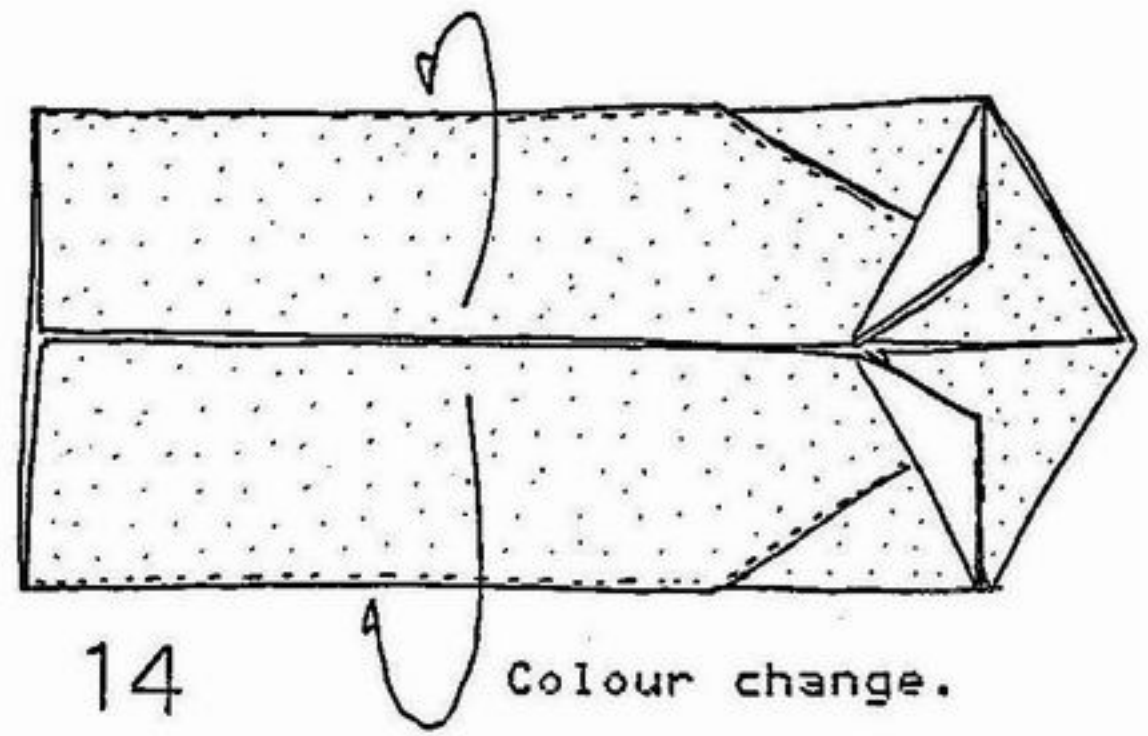
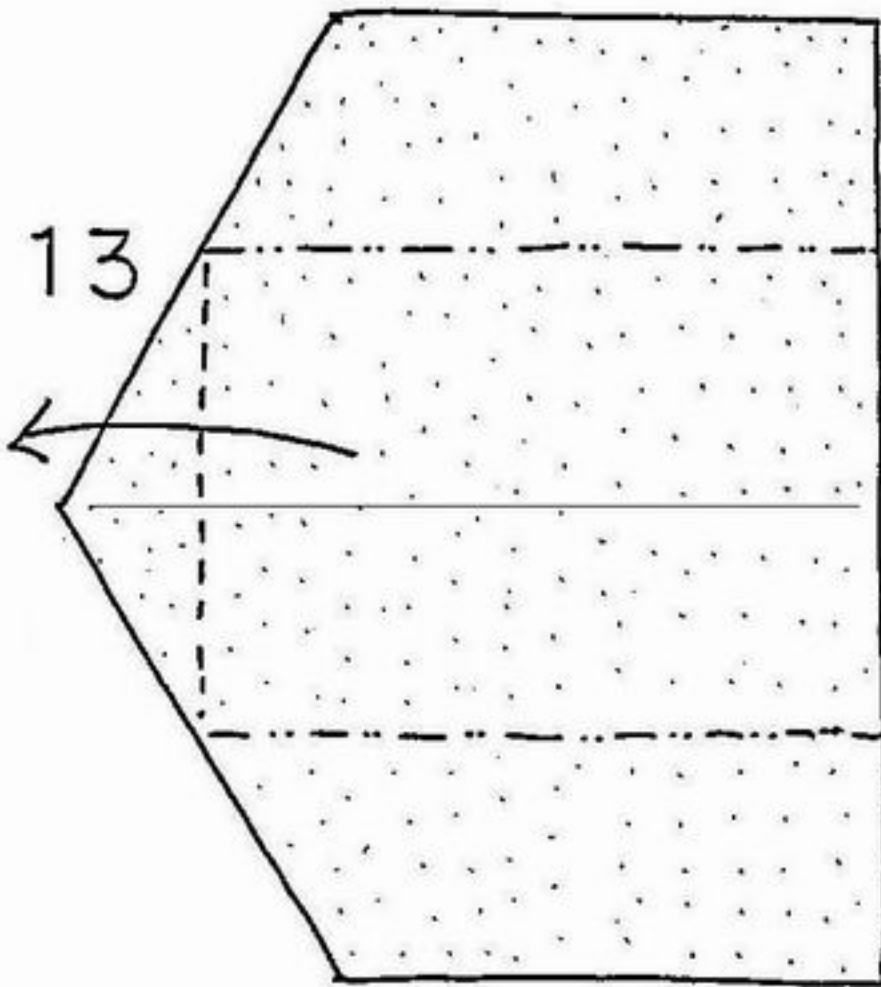

Tuck into pocket.

repeat steps 15 to 19  
for the bottom side.



21

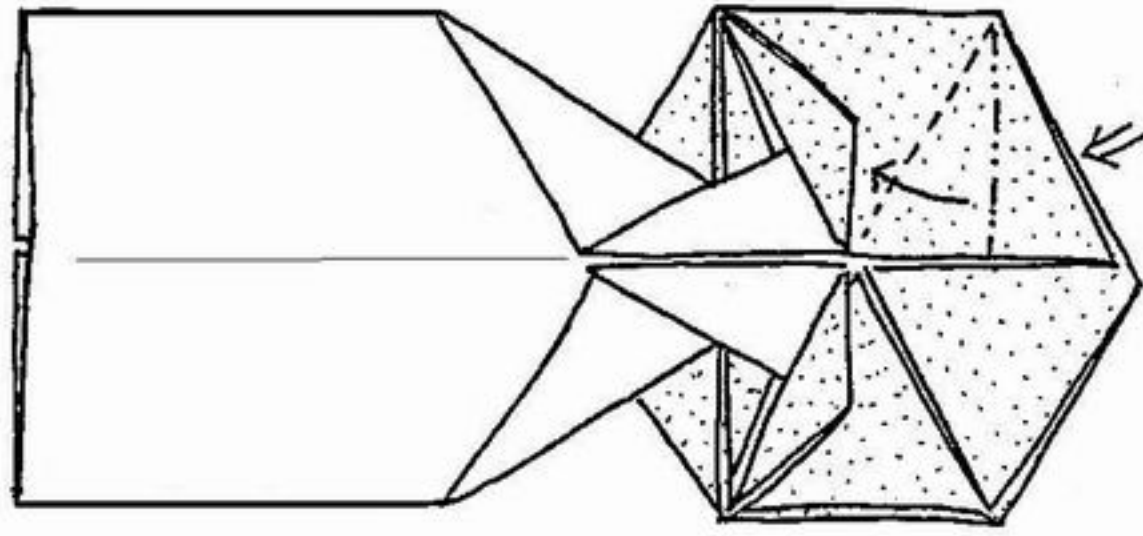

22

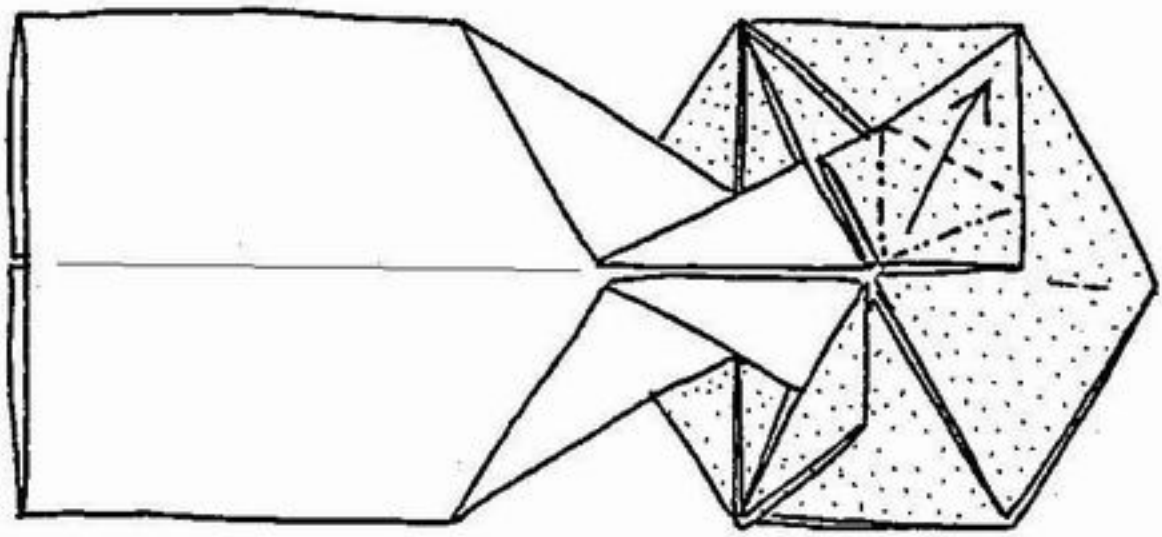

23

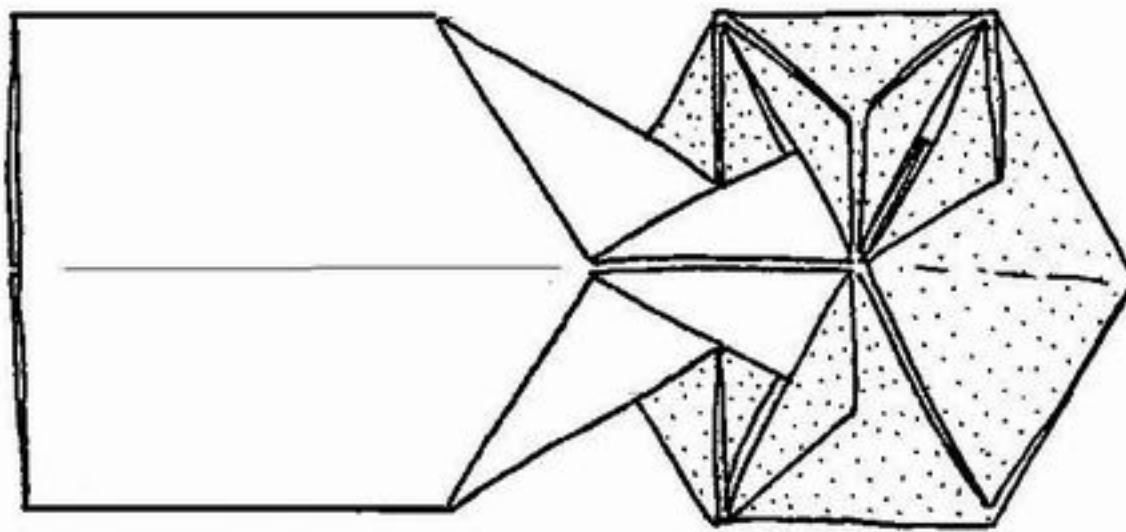

Repeat steps 21 and 22  
for the remaining 2 flaps.

24

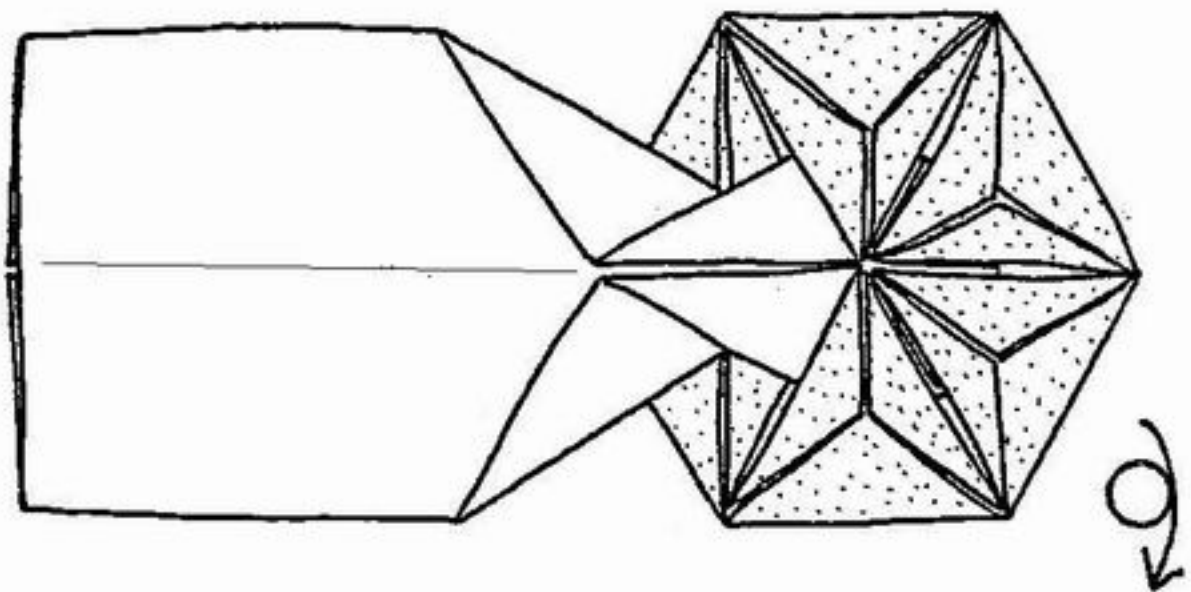

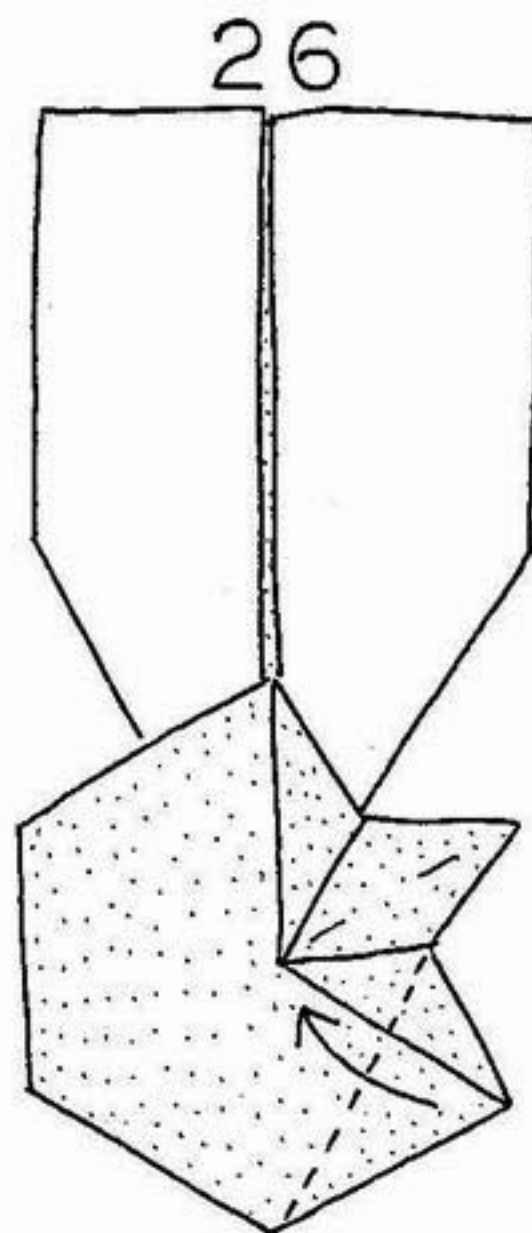
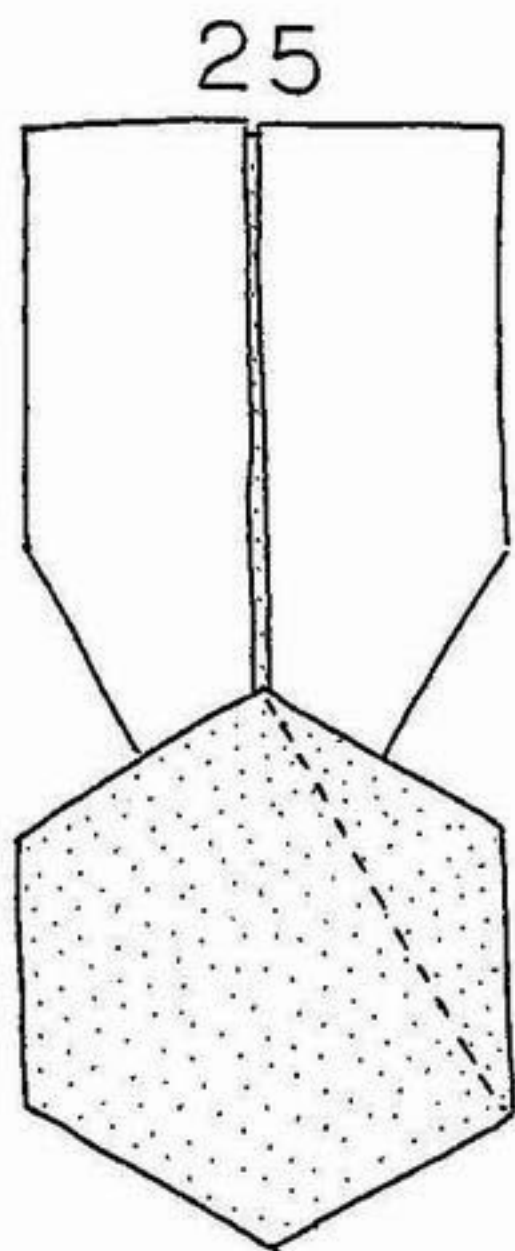

Repeat 3 times.

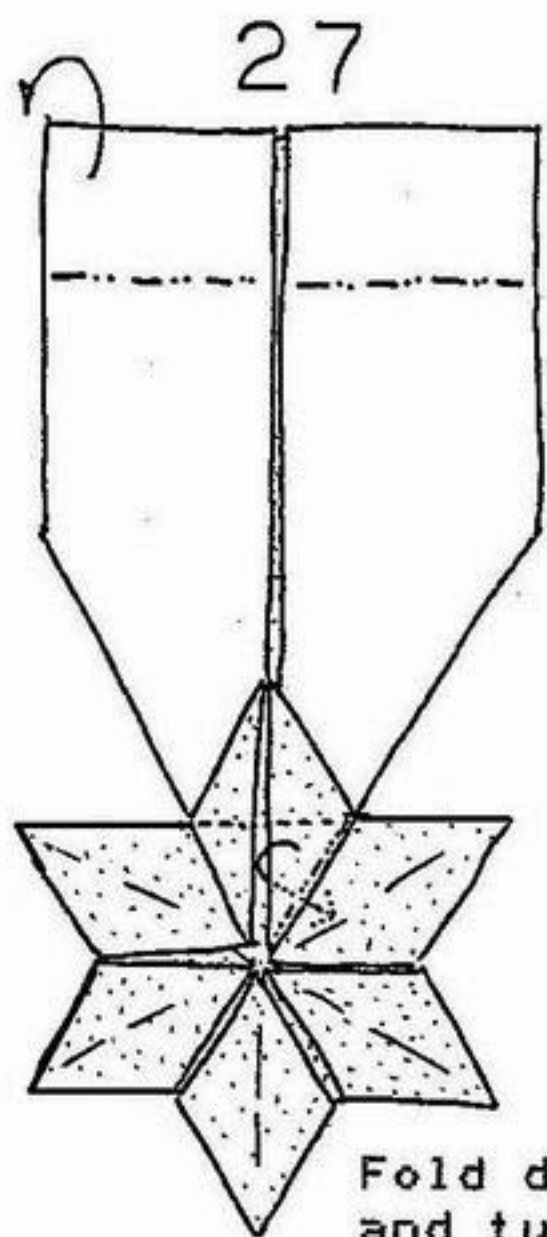

Fold down  
and tuck in.

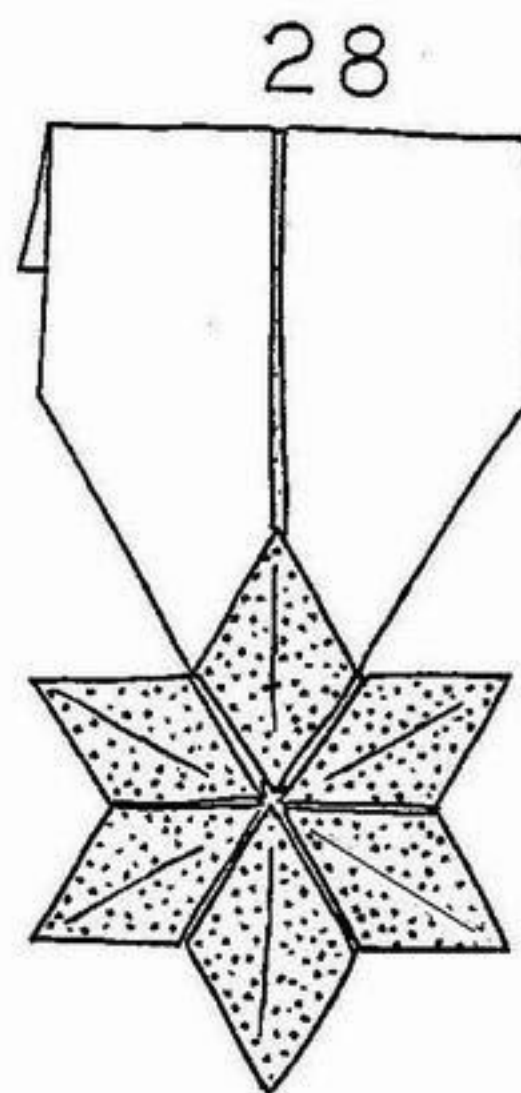

COMPLETE

Francis M. Y. Ow  
1985 /86

This diagram is available at Gabriel Vong's Ori-Scope <http://ori500.free.fr>  
with permission granted by the author.