

# DROMEDARIO

$(h \approx \frac{1}{3}l)$

GABRIEL ALVAREZ

20/3/80

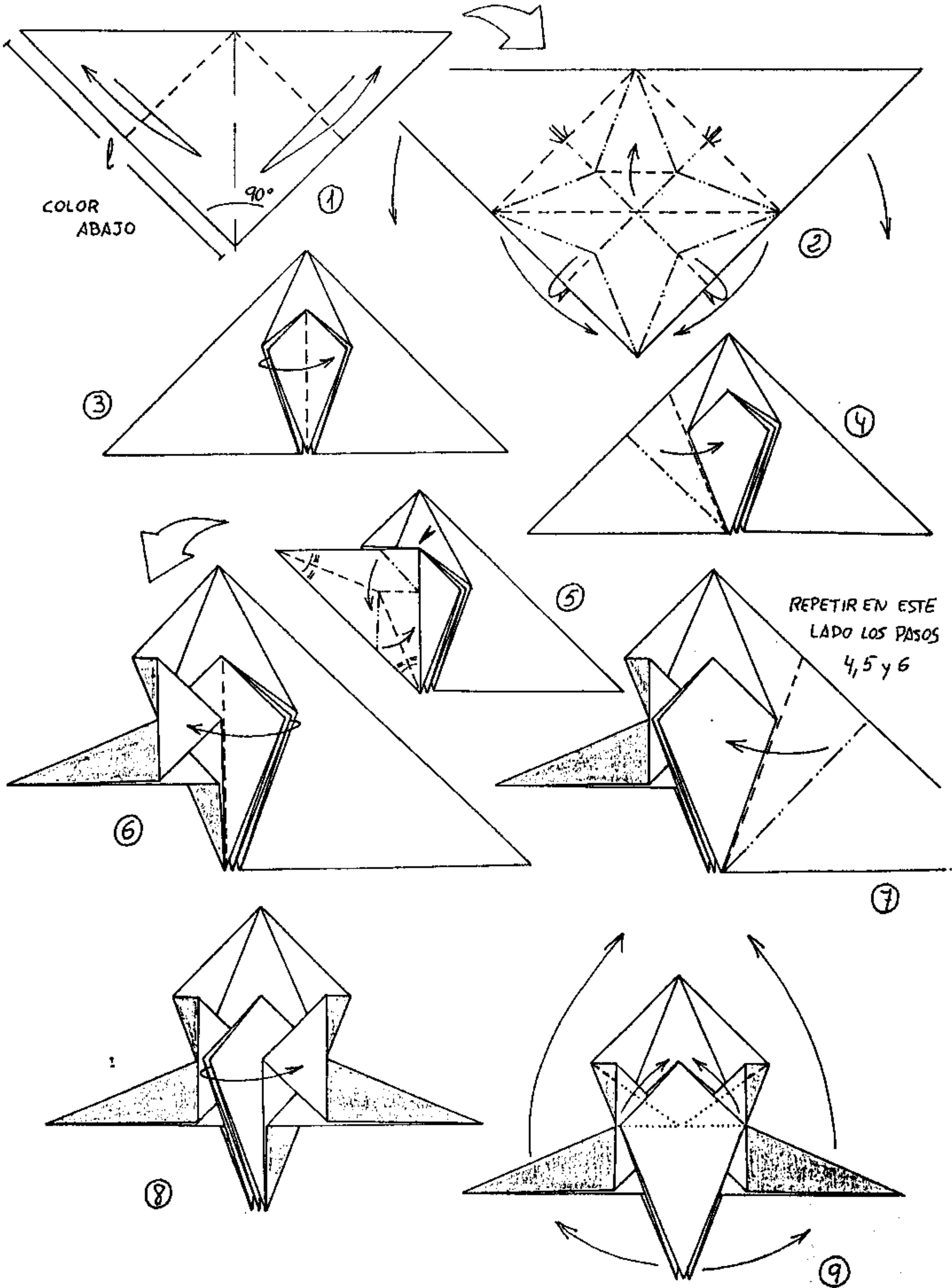

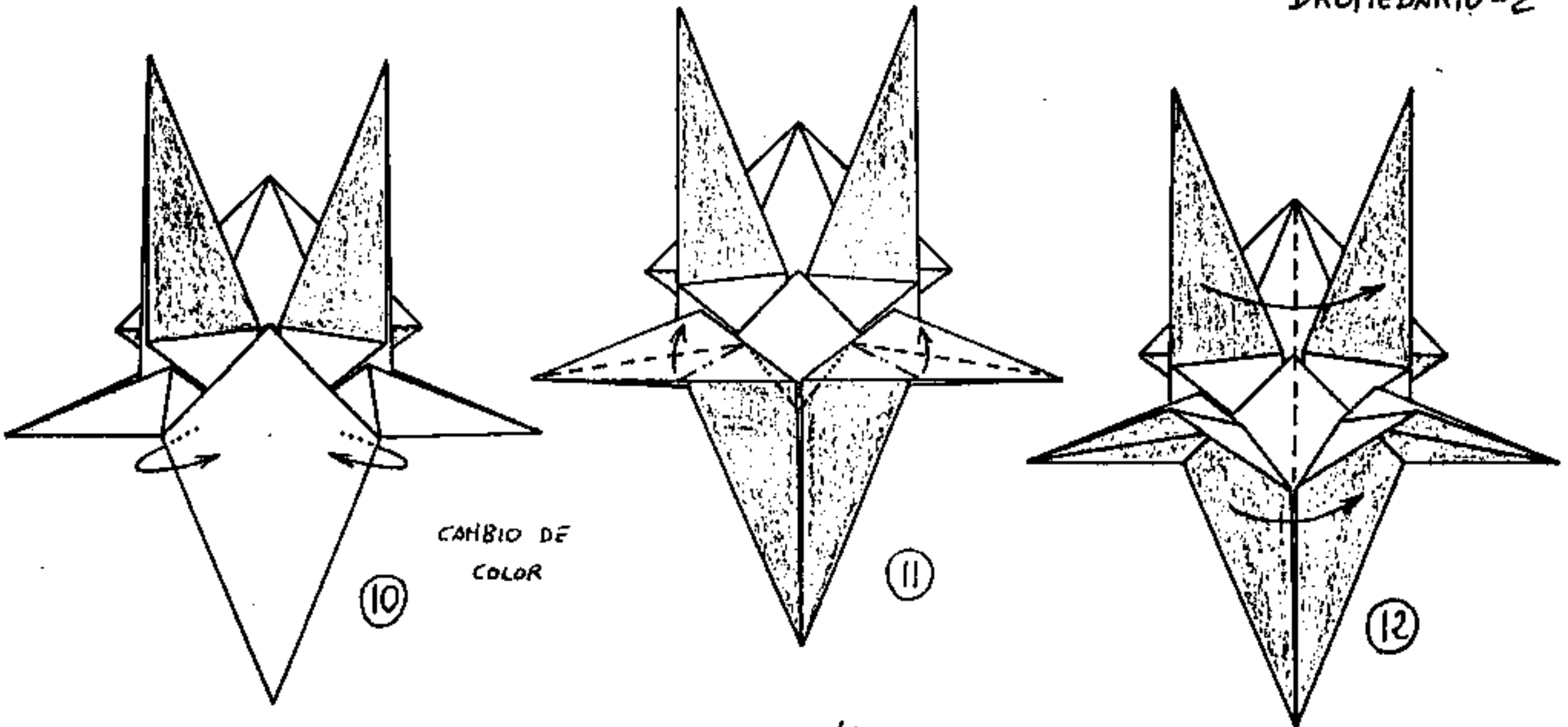

CAMBIO DE COLOR

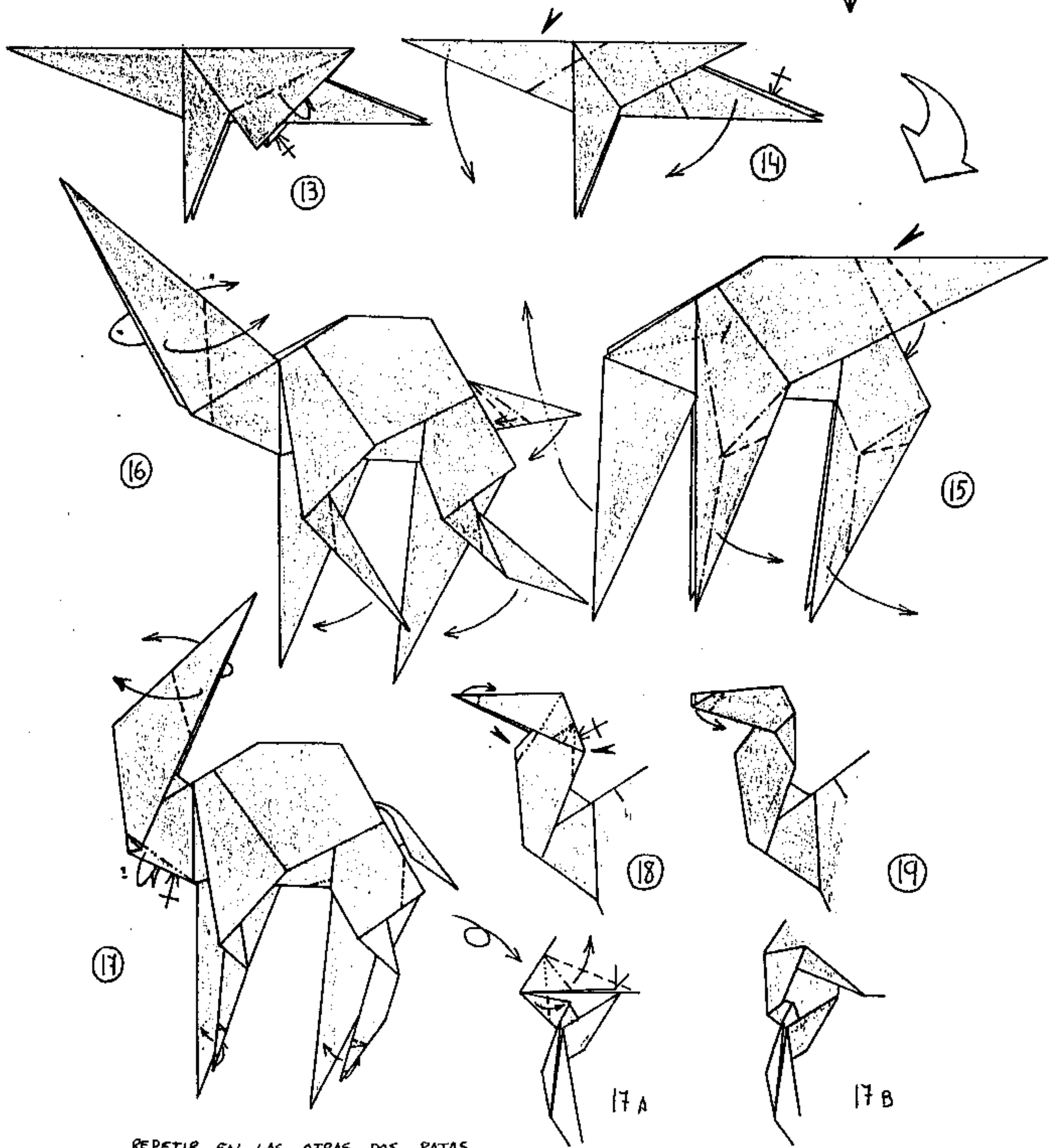

REPETIR EN LAS OTRAS DOS PATAS

20

DIBUJOS: GABRIEL ALVAREZ  
14/6/80

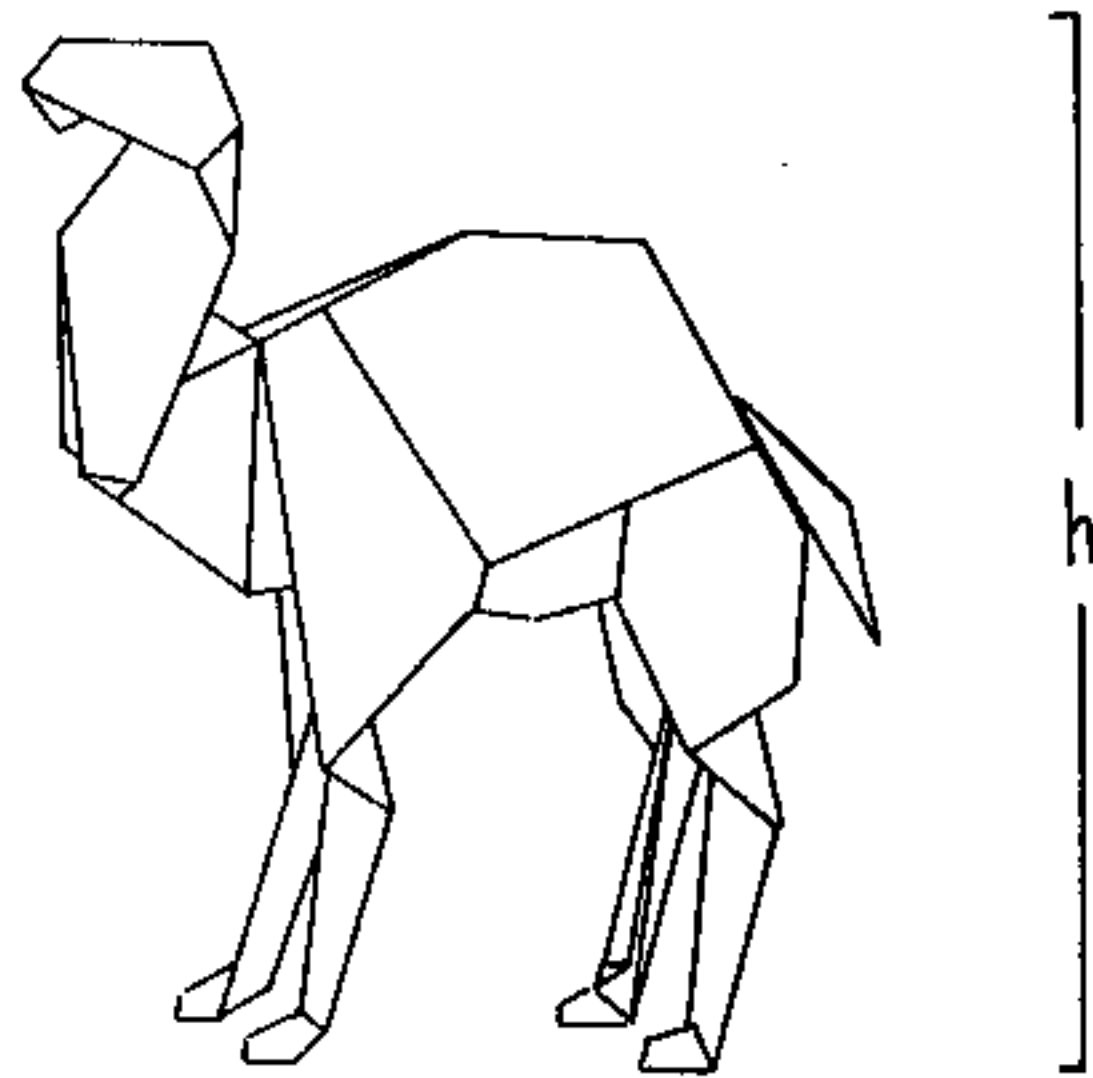

VARIANTE: TUAREG (O REY MAGO)

EMPEZAR INVIRTIENDO LOS COLORES

DAR LA VUELTA A LA FIG. 3 DEL DROMEDARIO

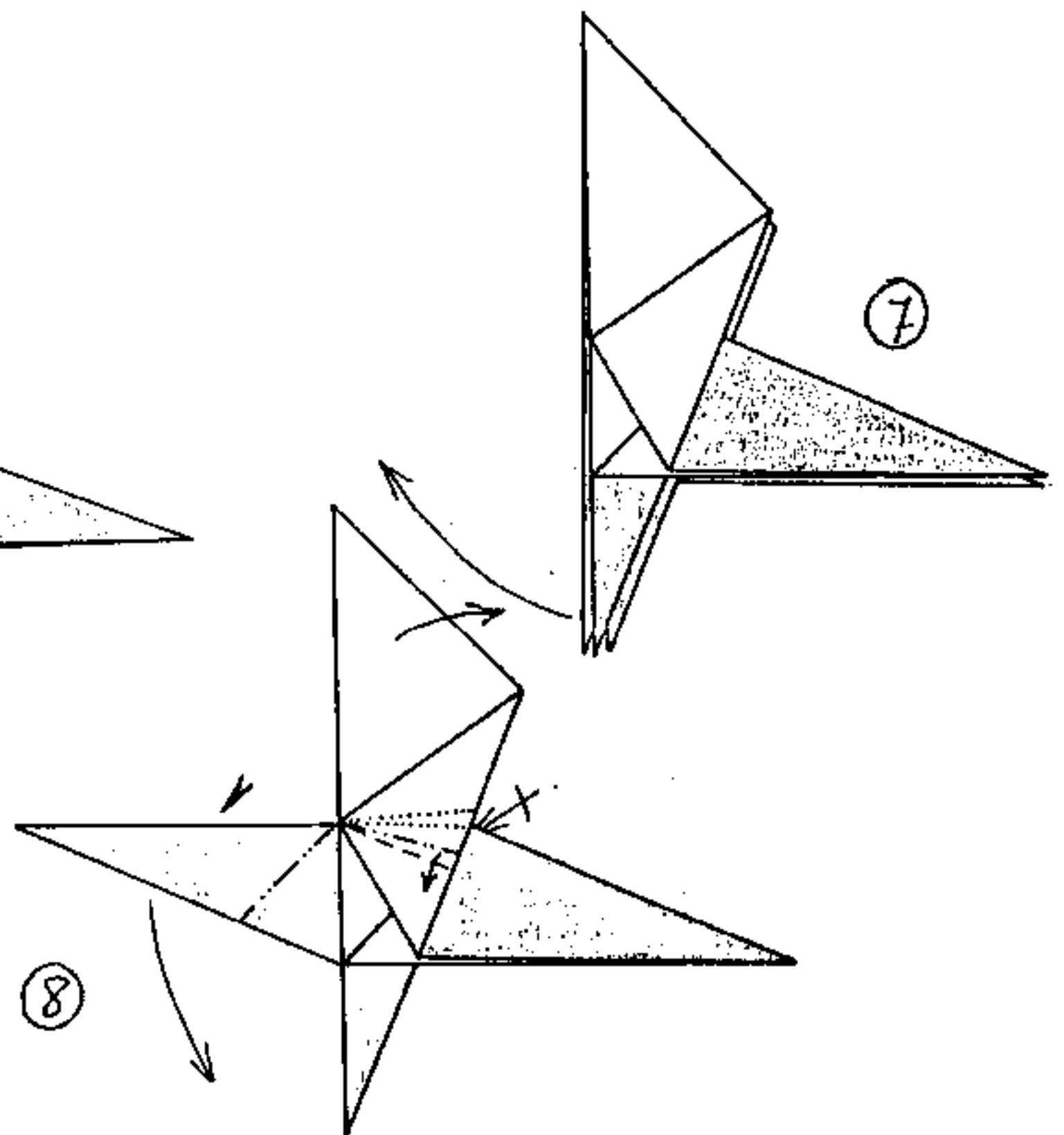
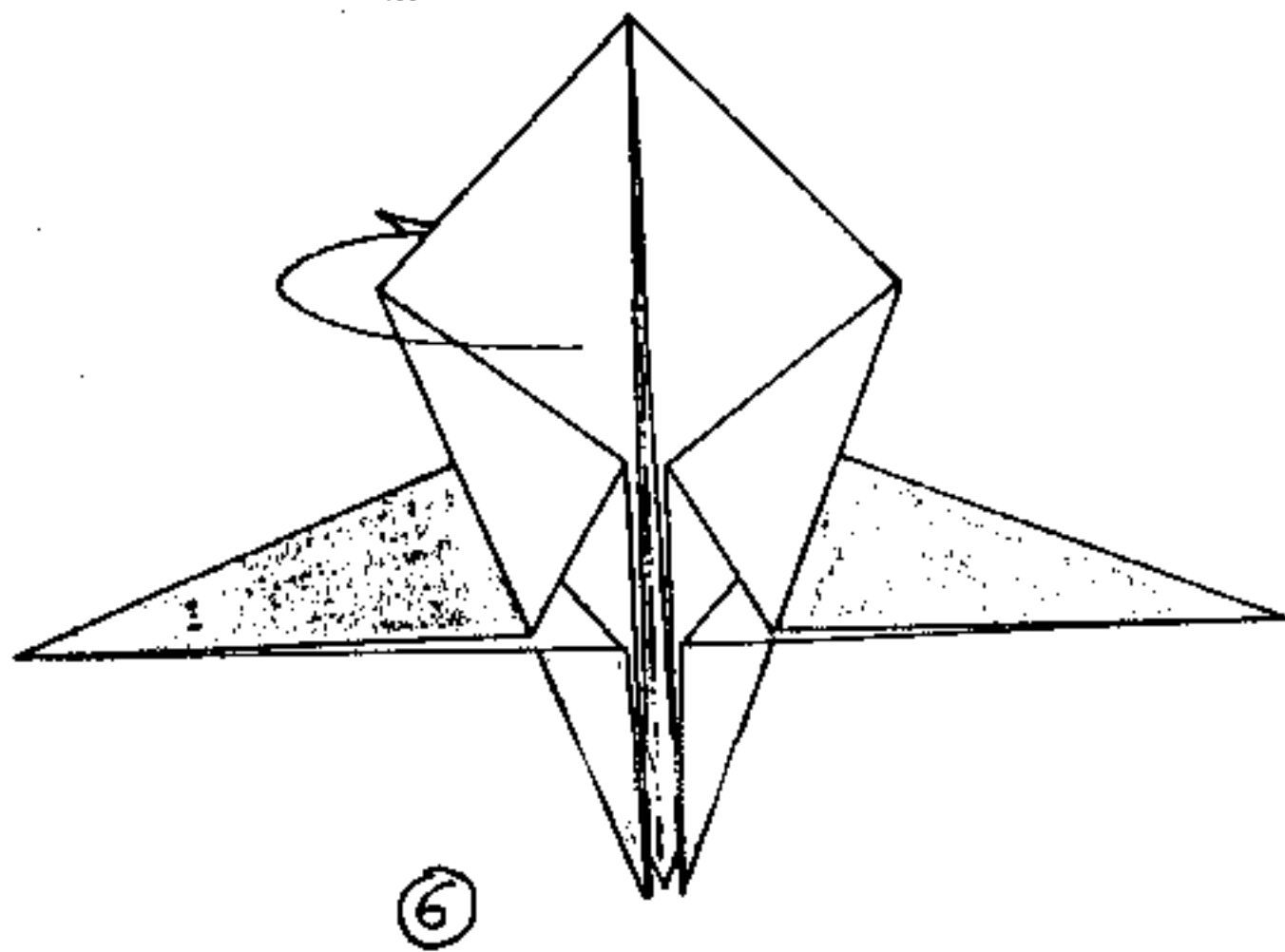
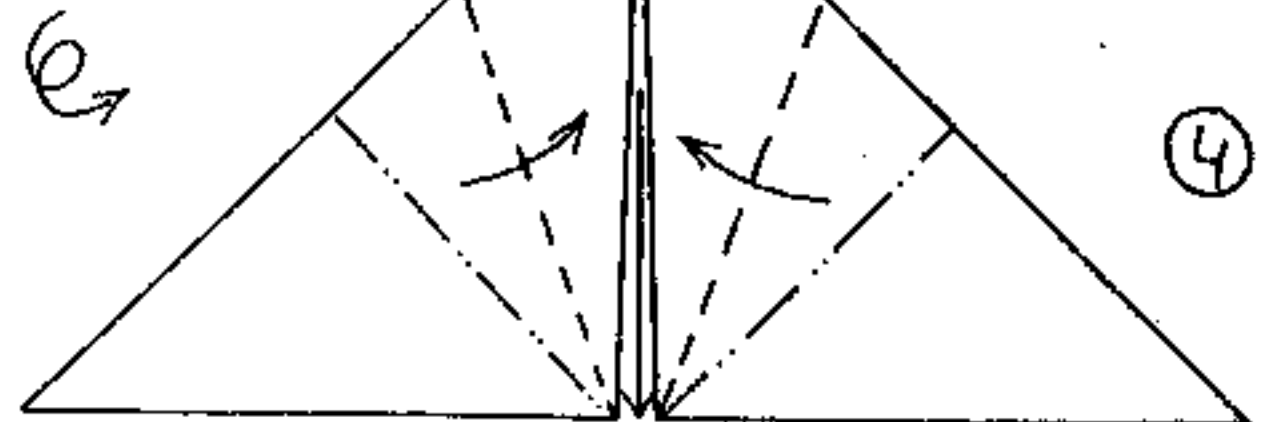
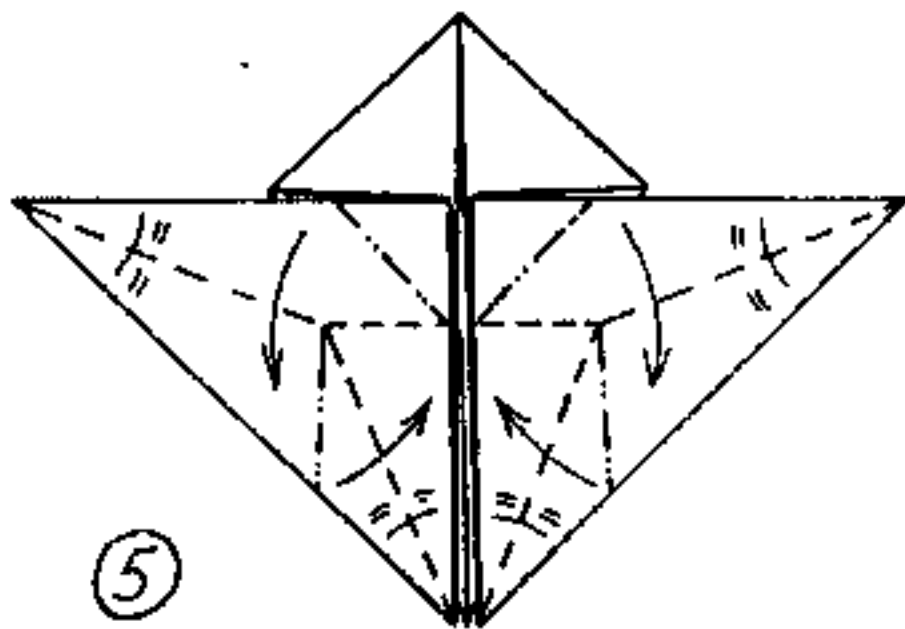

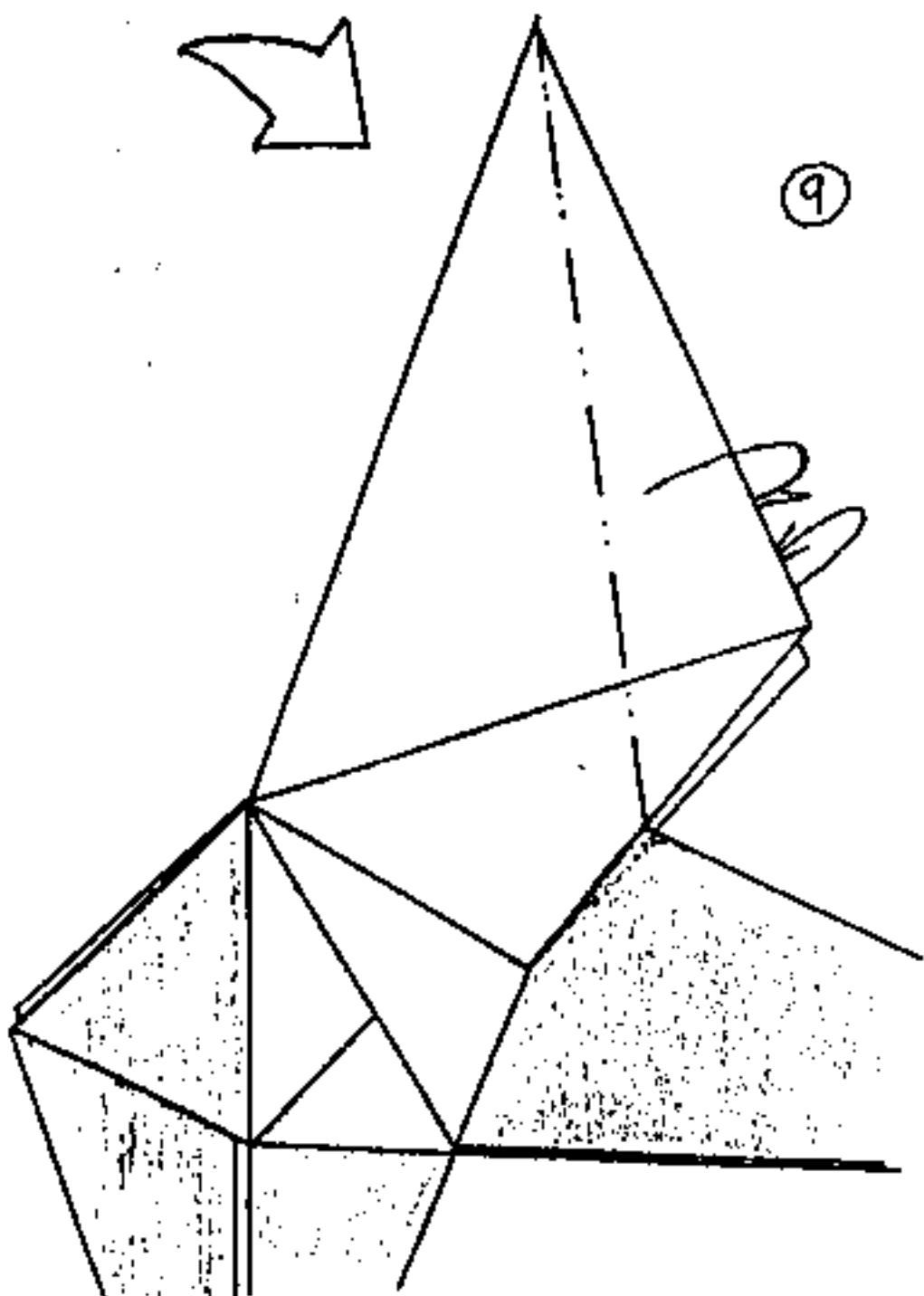

9

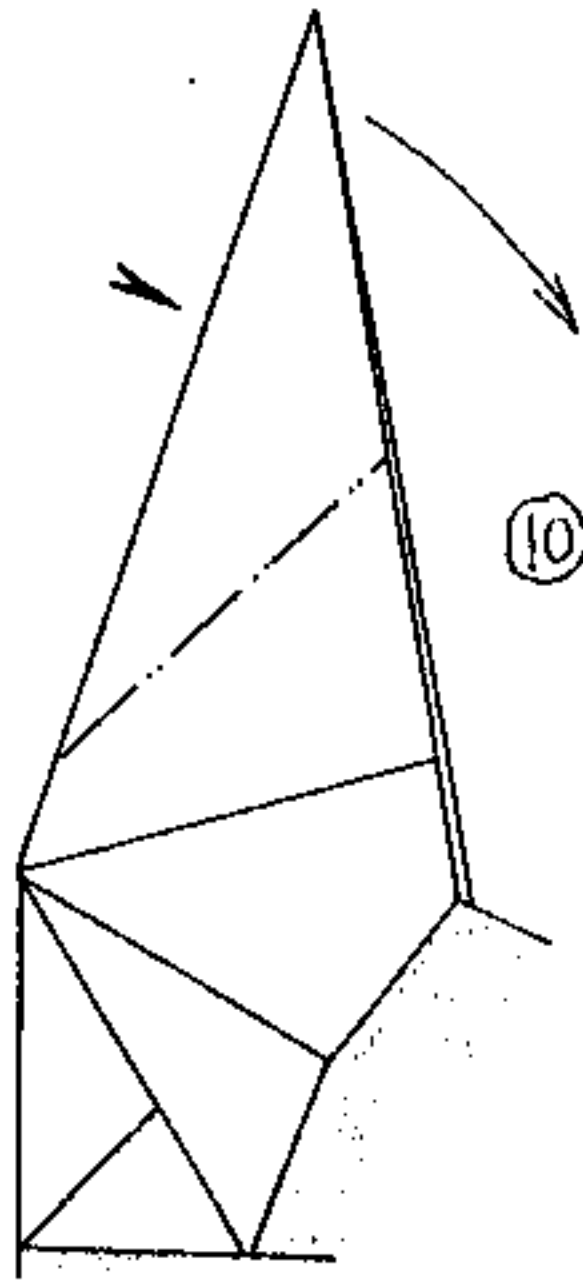

10

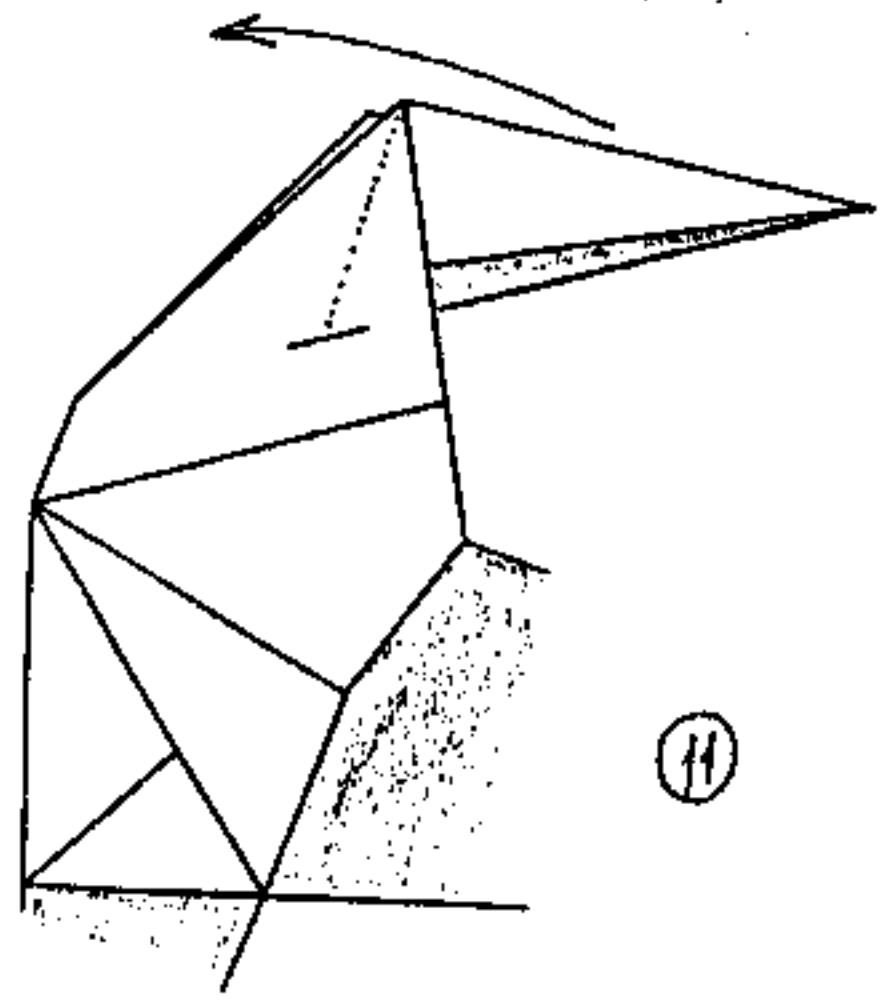

11

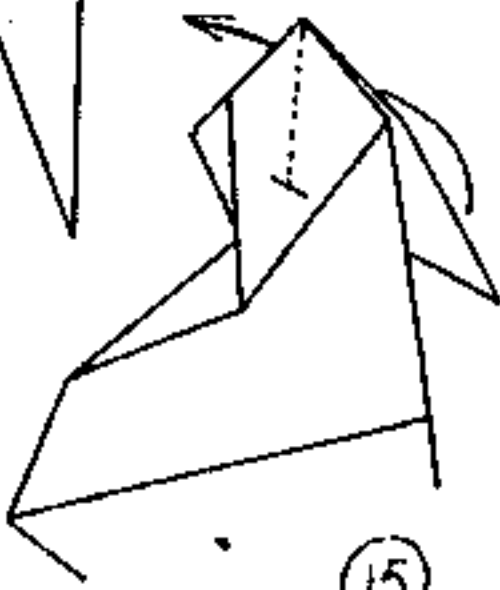

15



14

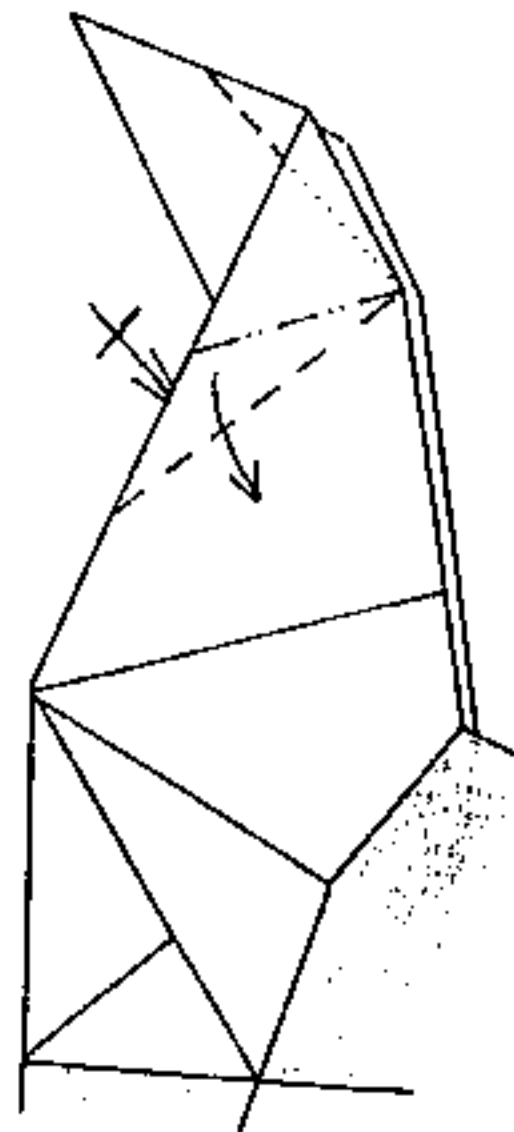

13

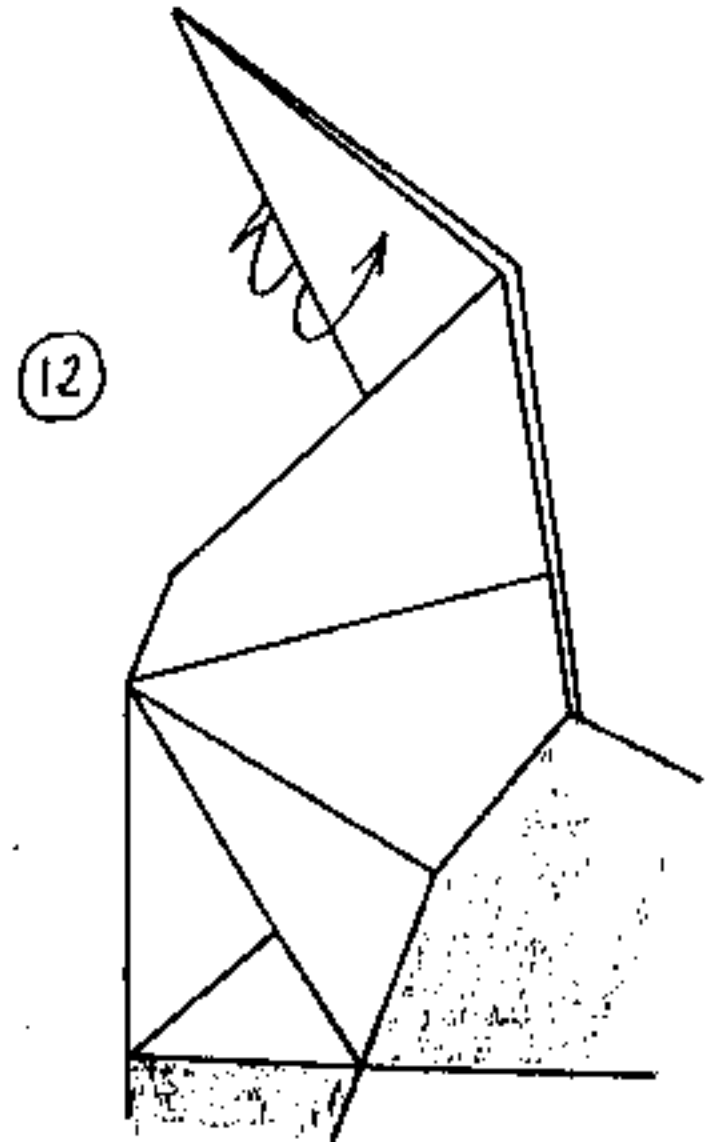

12

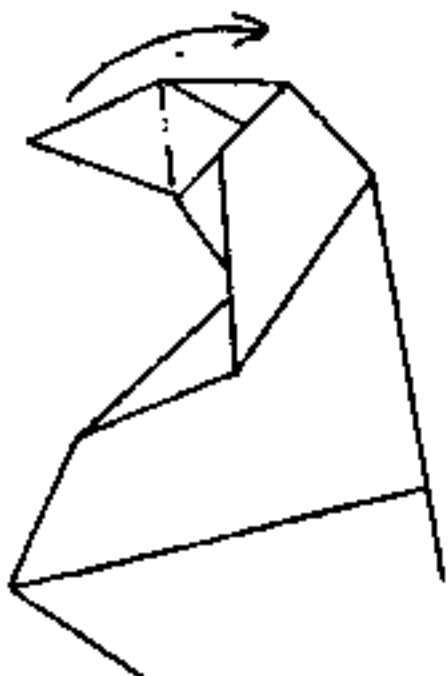

16

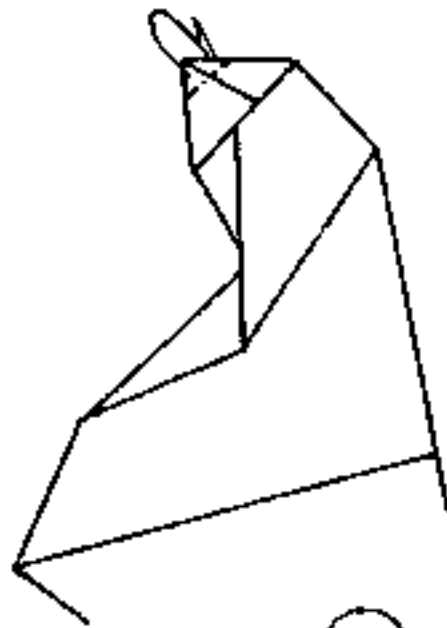

17

SEGUIR COMO EN LA FIG. 15 DEL DROMEDARIO.

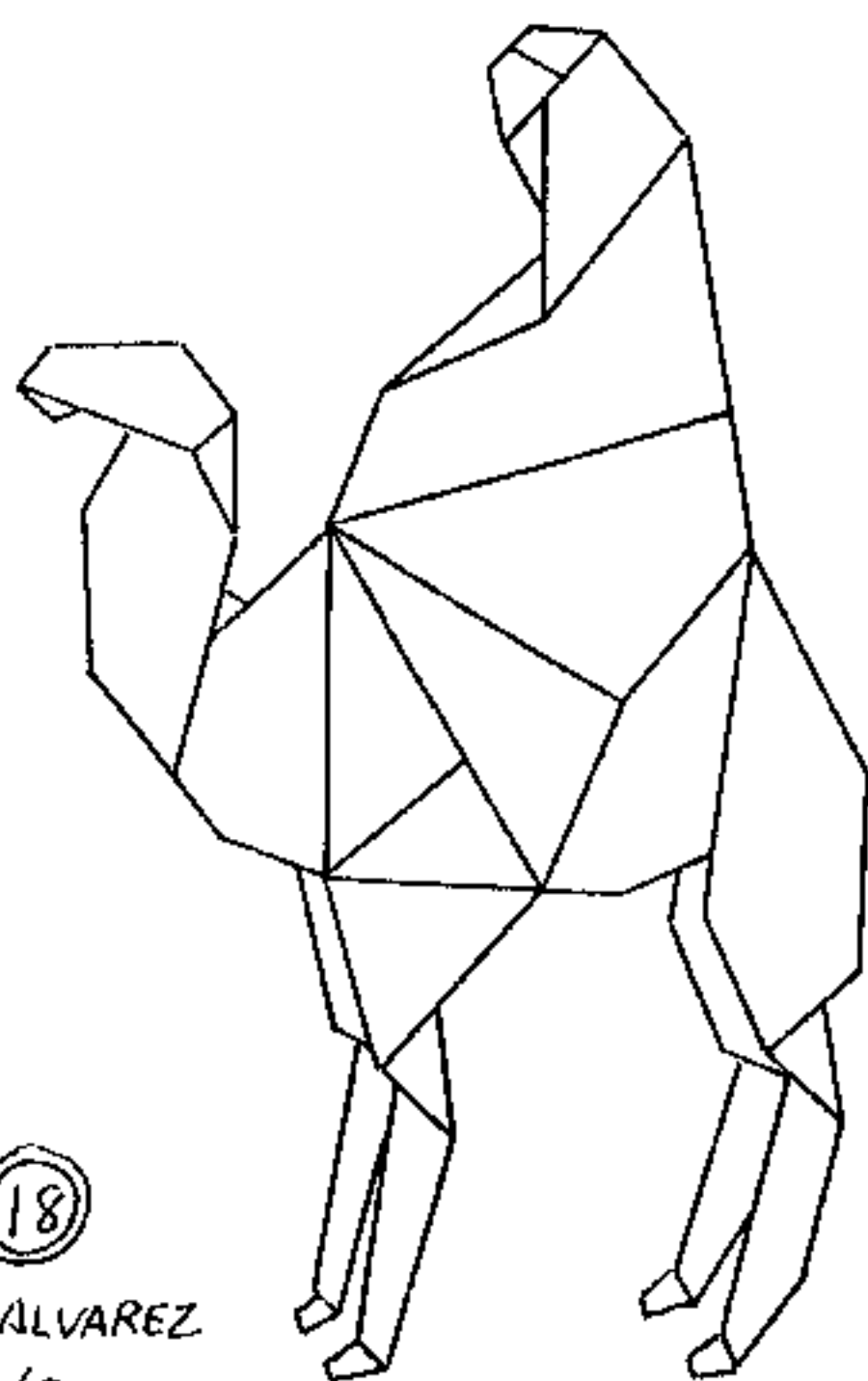

18

DIBUJOS: GABRIEL ALVAREZ  
14/6/80