

Bufón

©Fernando Gilgado (2008)

elfernan3@hotmail.com

www.pajarita.org/usuarios/gilgado/

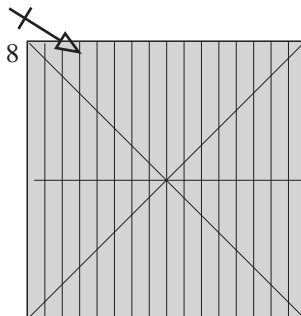
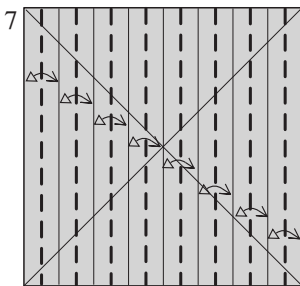
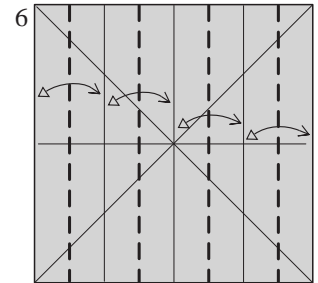
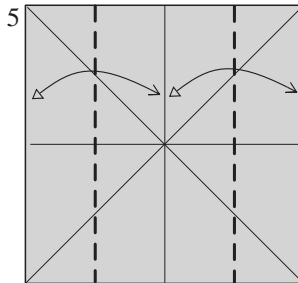
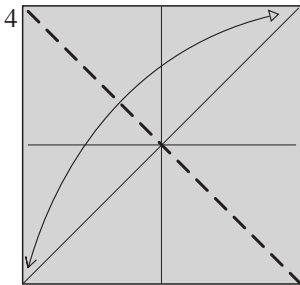
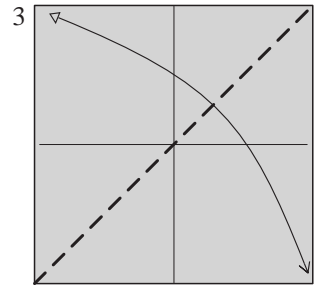
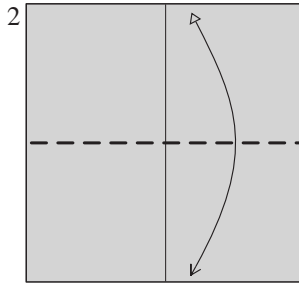
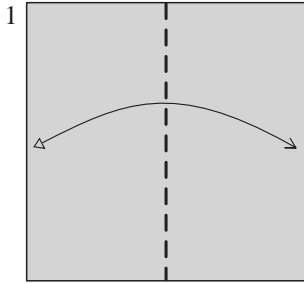
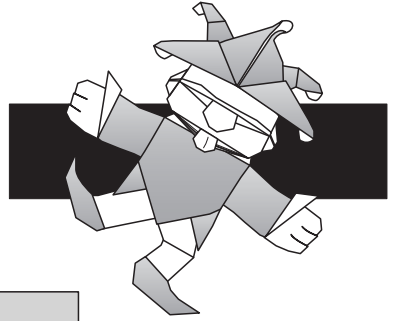

Repetir 5-7 en el otro lado

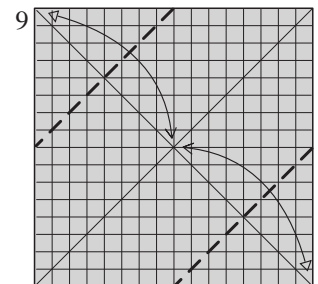

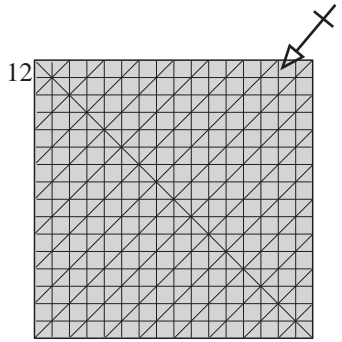
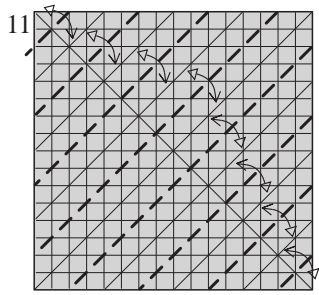
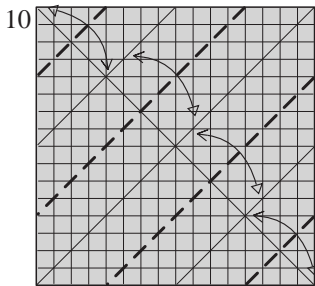

Repetir 9-11 en la otra esquina

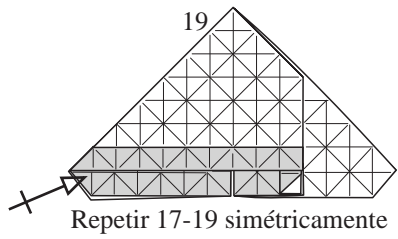
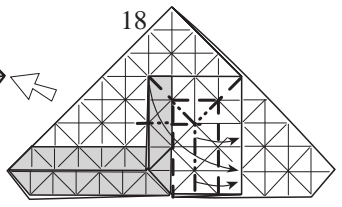
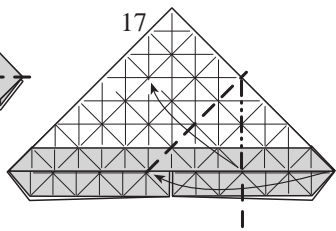
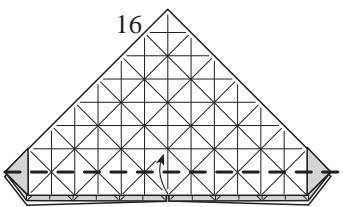
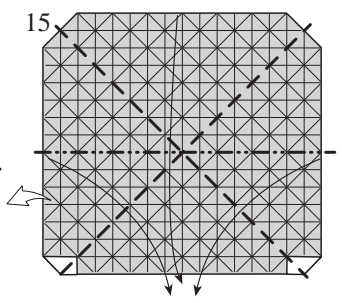
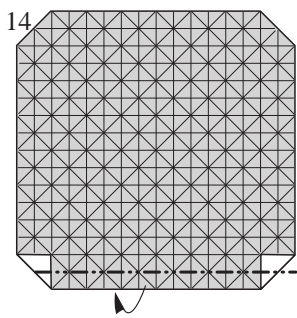
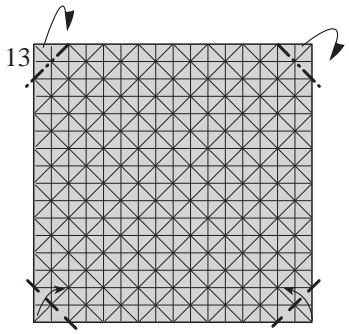

Repetir 17-19 simétricamente

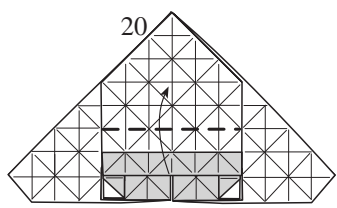

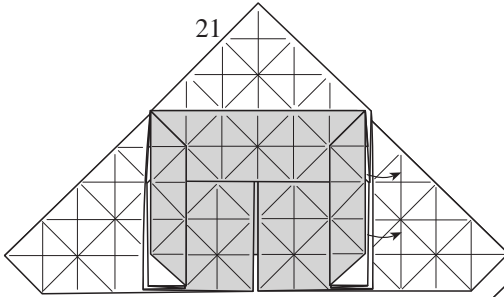

21

Sacar el papel

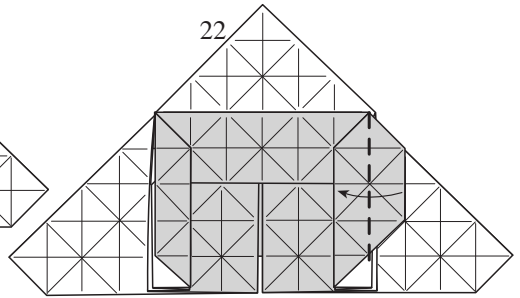

22

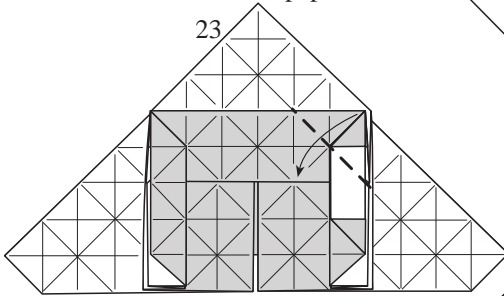

23

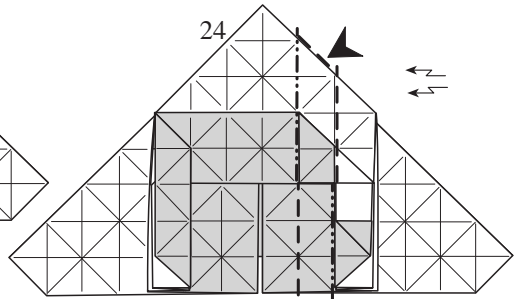

24

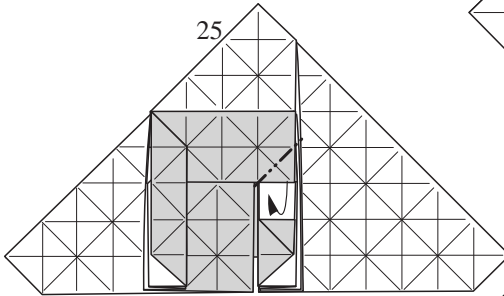

25

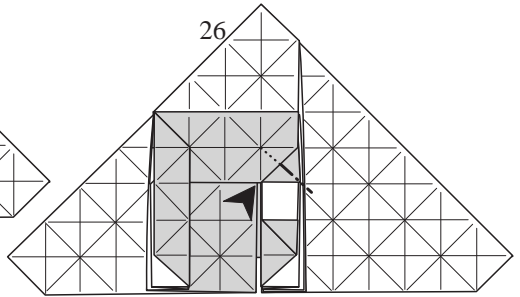

26

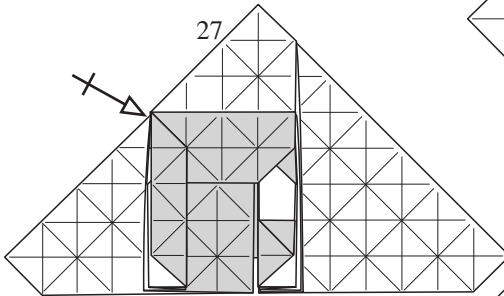

27

Repetir 21-26 simétricamente

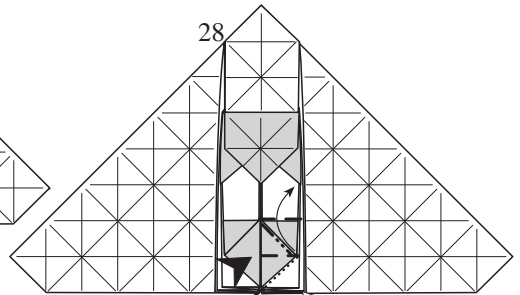

28

Estirar y aplastar

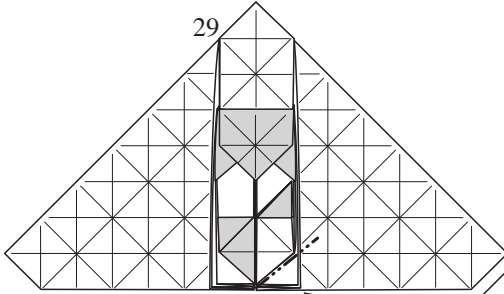

29

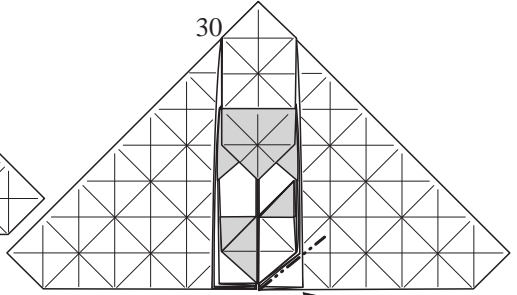

30

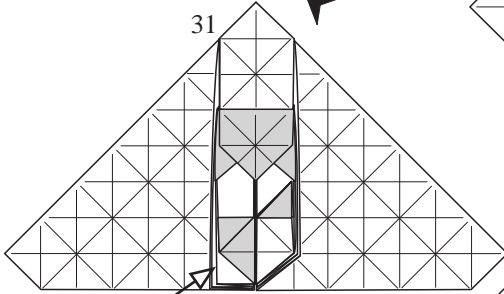

31

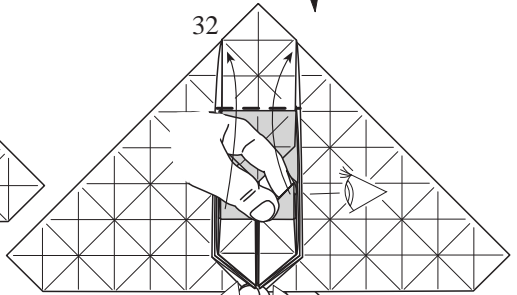

32

Repetir 28-30
simétricamente

Estirar el papel para
hacer las piernas

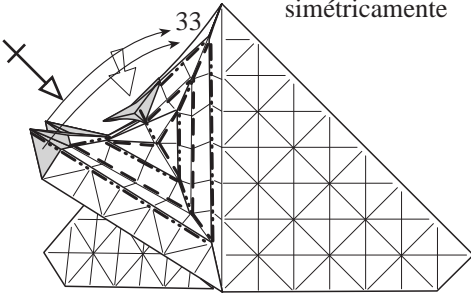

33

Vista intermedia. Repetir en el otro lado

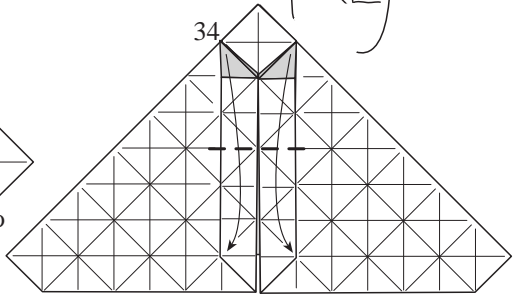

34

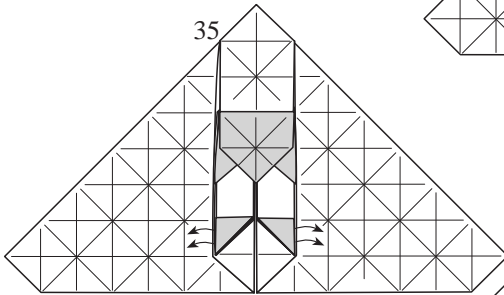

35

Sacar el papel

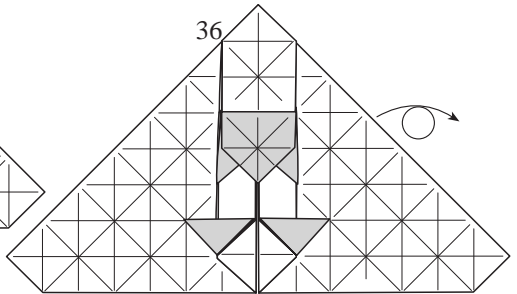

36

Dar la vuelta

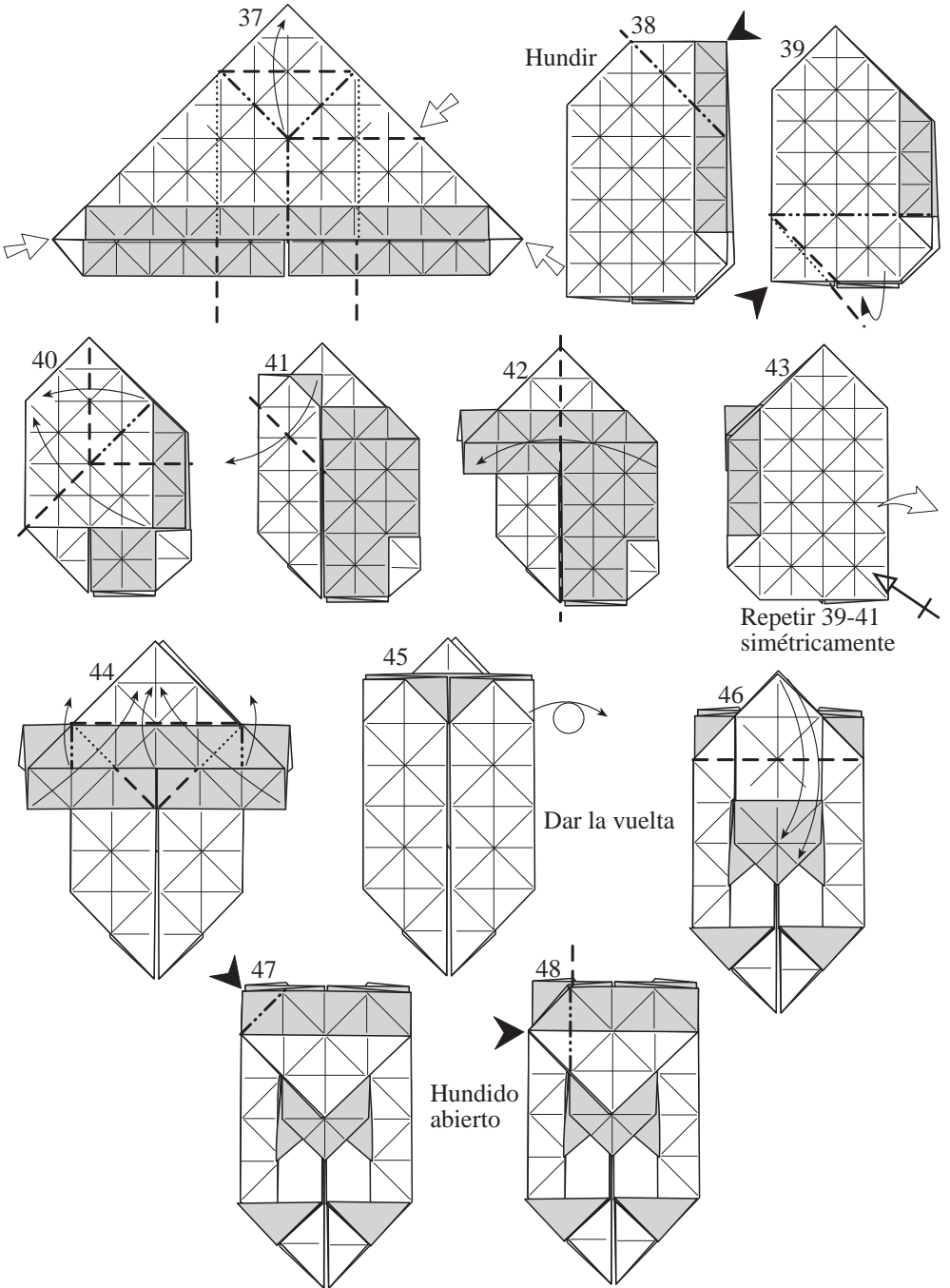

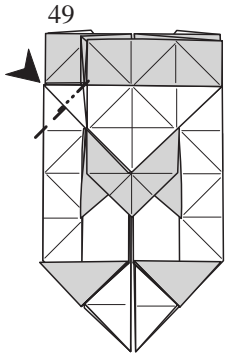

Hundido abierto

Hundido abierto

Hundido cerrado

Hundido abierto

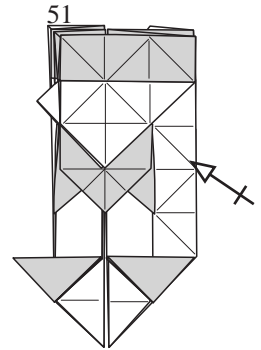
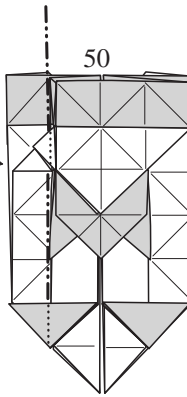

Repetir 47-50 simétricamente

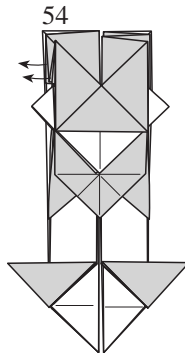
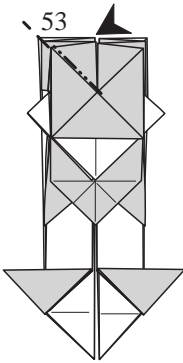
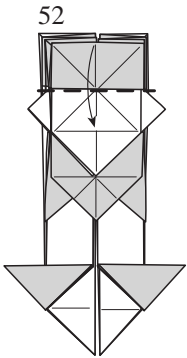

Sacar el papel

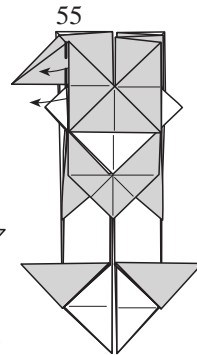

Sacar el papel

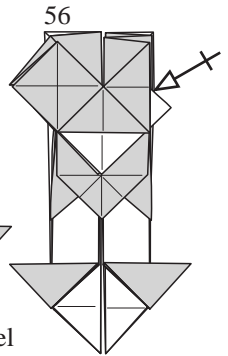

Repetir 53-55 simétricamente

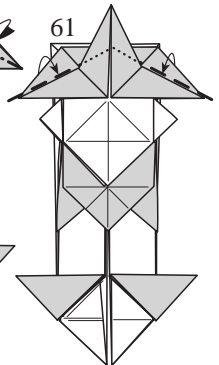
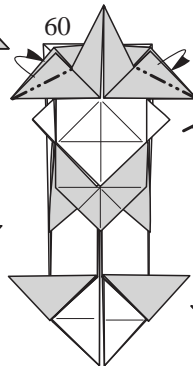
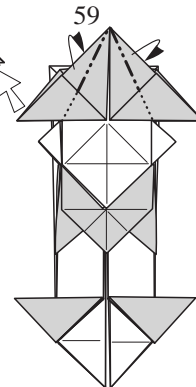
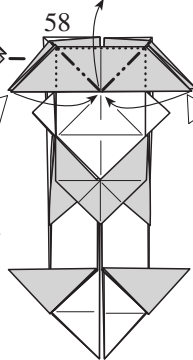
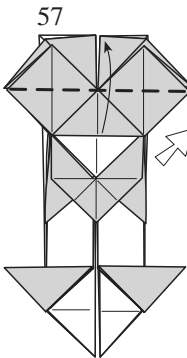

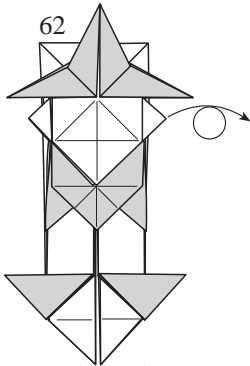

62
Dar la vuelta

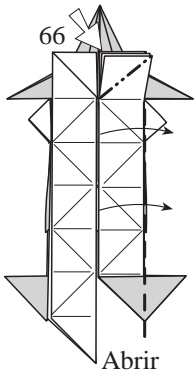
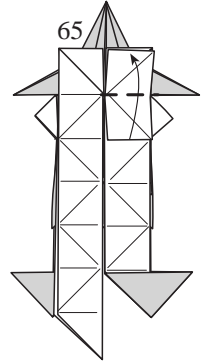
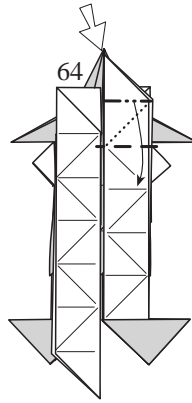
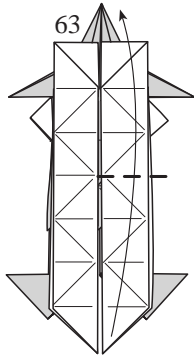

66
Abrir

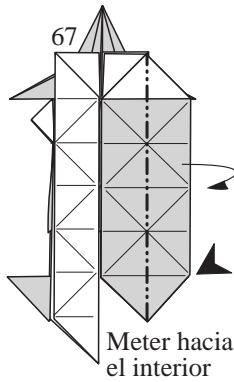

67
Meter hacia el interior

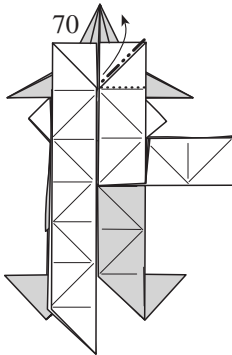
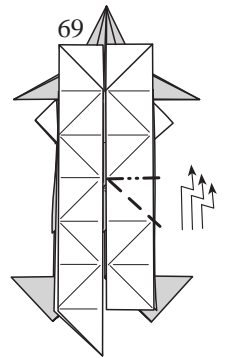
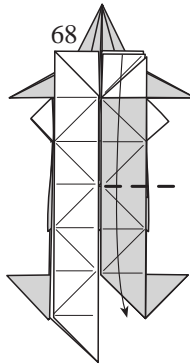

70
Sacar el papel

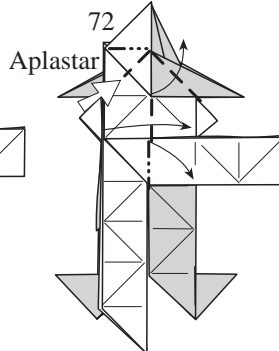
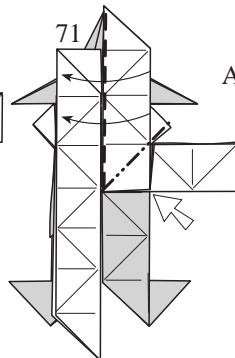

72
Aplastar

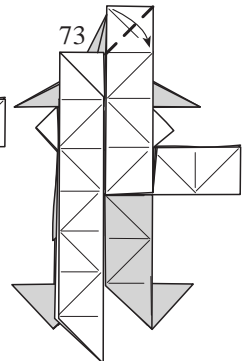

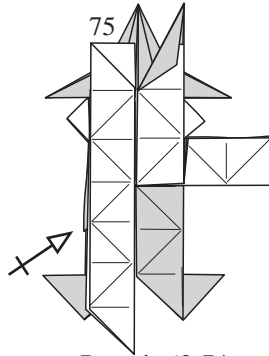
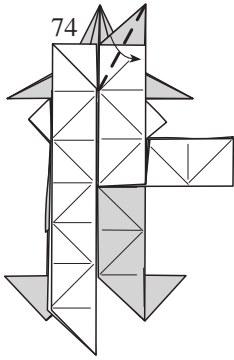

Repetir 63-74
simétricamente

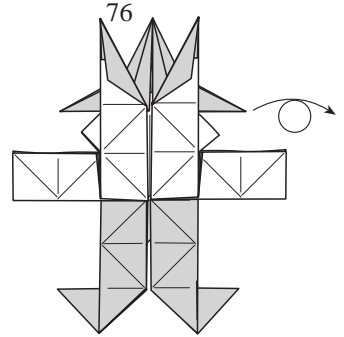

Dar la vuelta

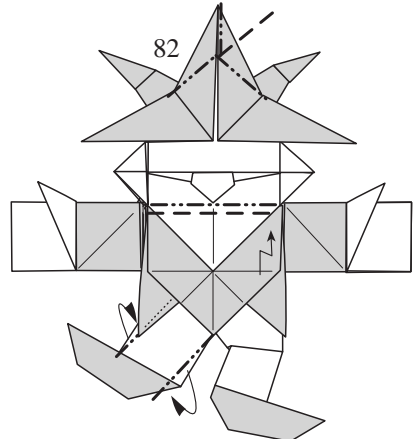
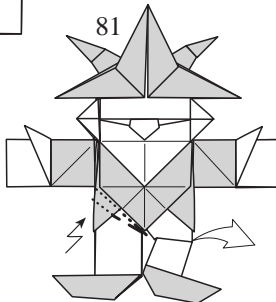
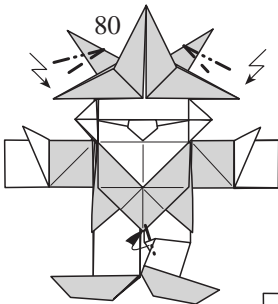
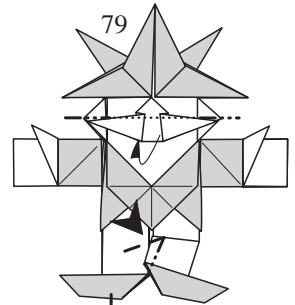
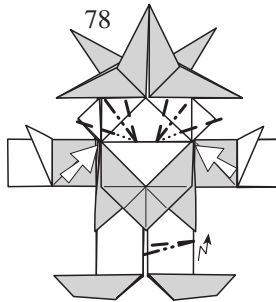
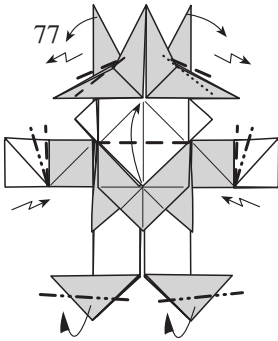

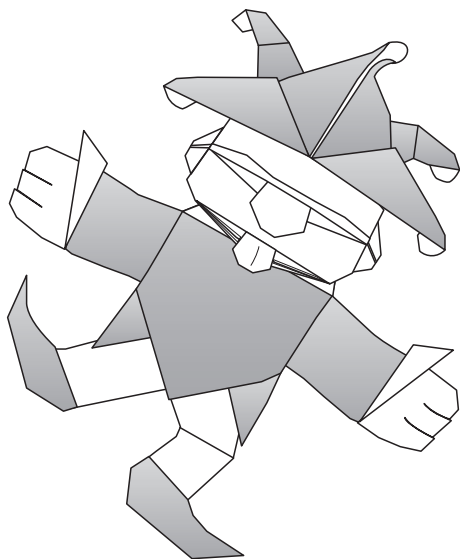
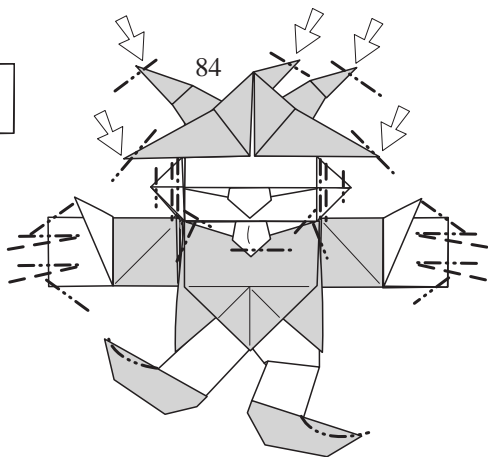
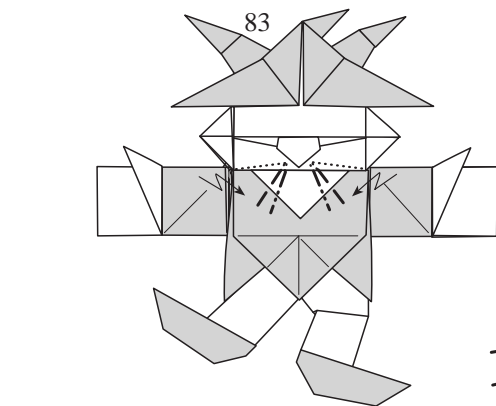

Este modelo lo diseñé porque un amigo tiene un grupo de música llamado “La Sangre del Bufón” y después de un concierto, me preguntó si era capaz de inventar un Bufón para el grupo. Me arriesgué (debido a la cervezas) y dije que sí. Así que estuve 15 días dándole vueltas pero al final a mi colega le gustó el modelo.