

# Angel

Author: Neal Elias

Modified by: Gabriel Vong

Diagramed by: Huy Pham

Date: Oct 2009

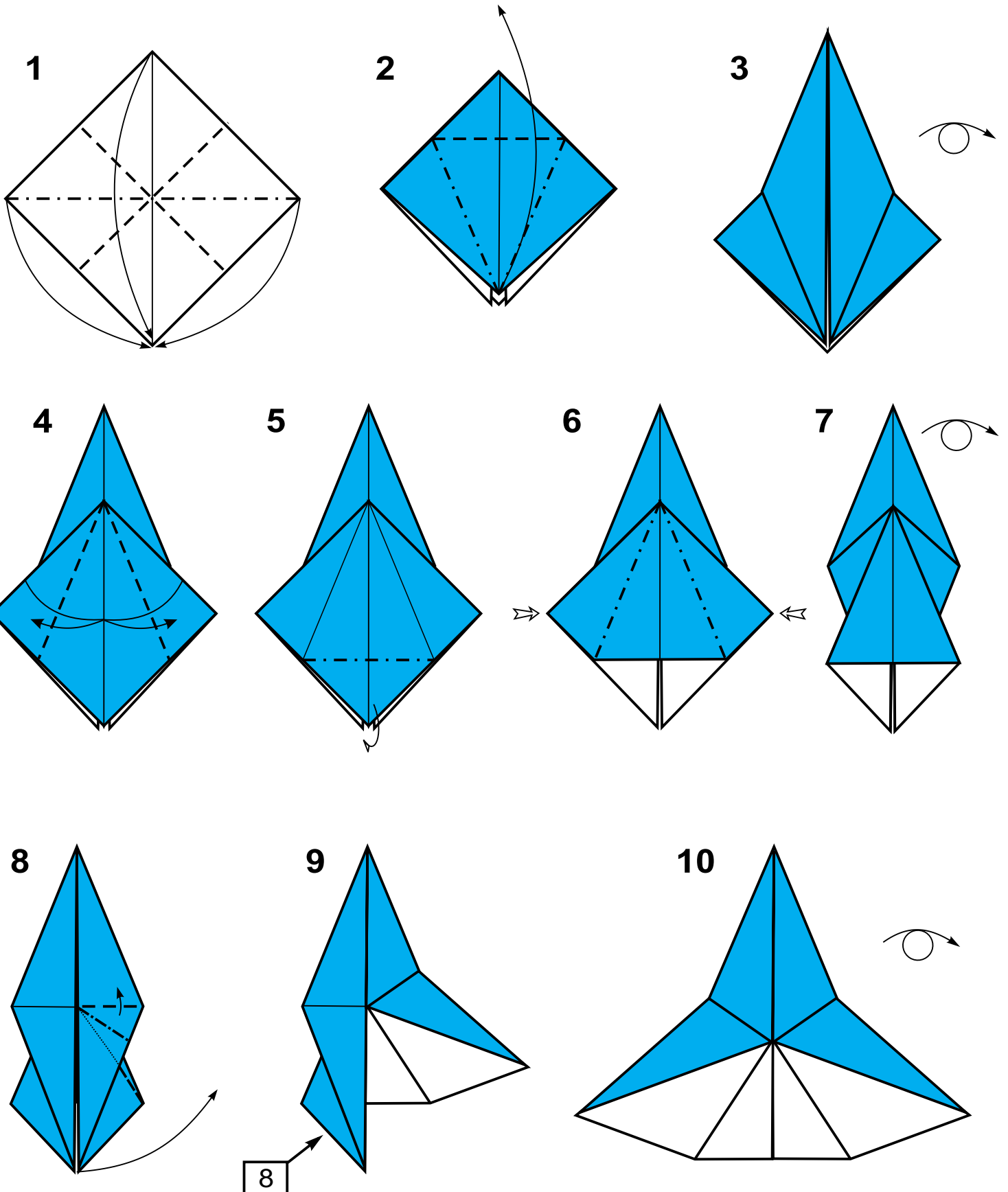
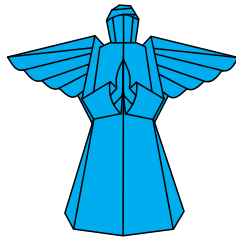

11

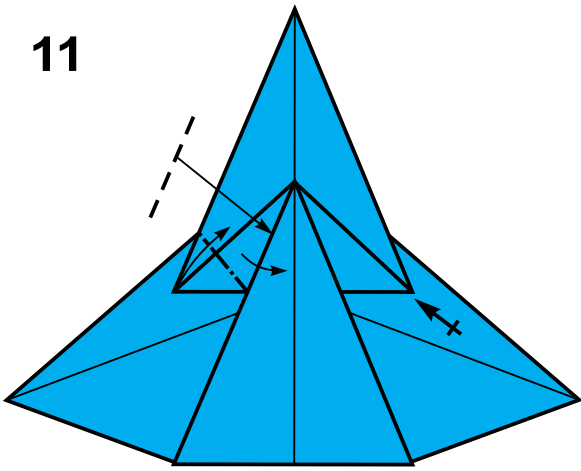

12

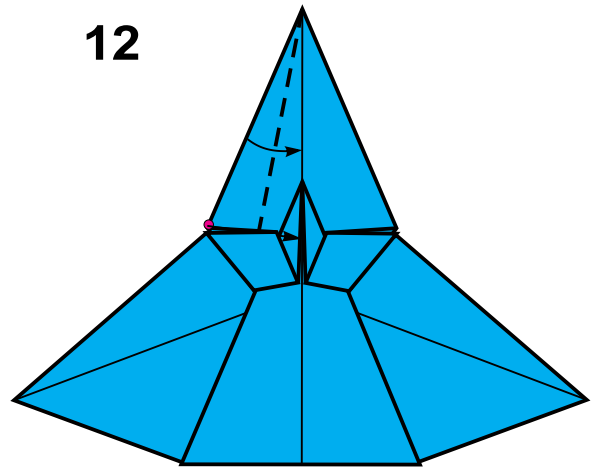

13

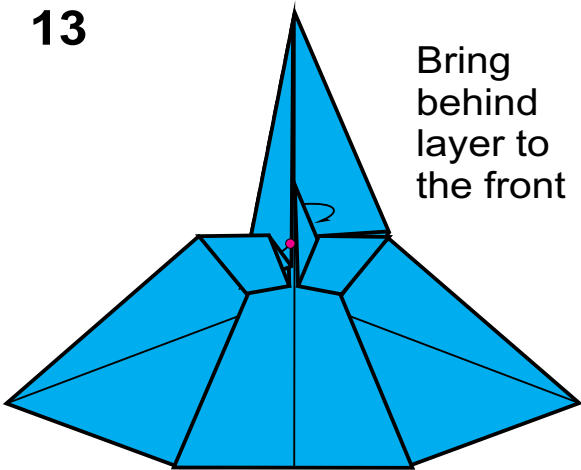

Bring behind layer to the front

14

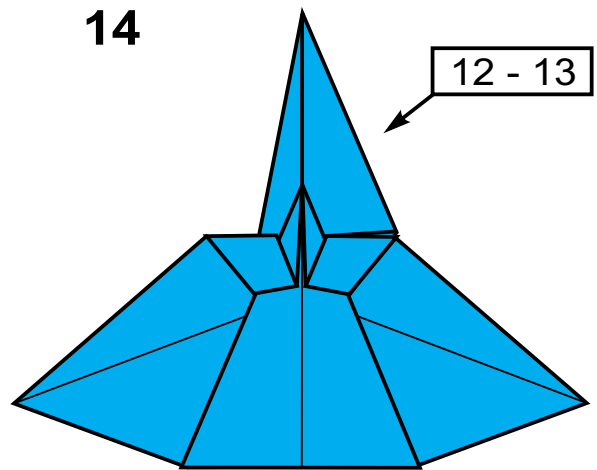

15

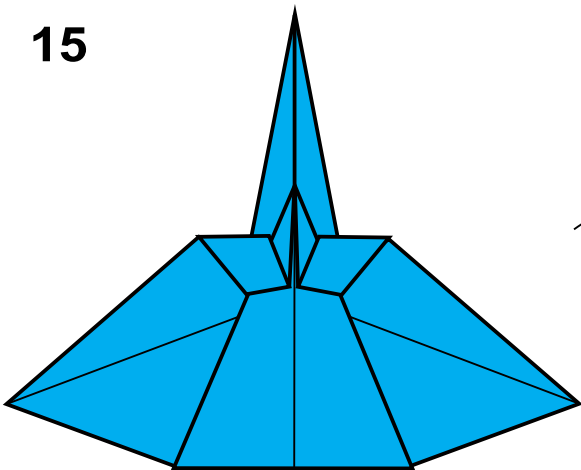

16

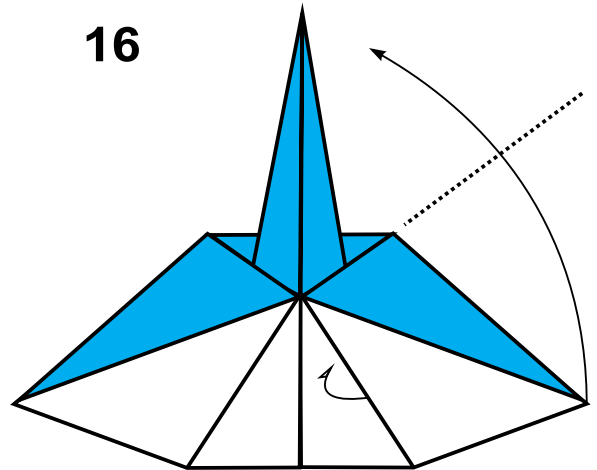

17

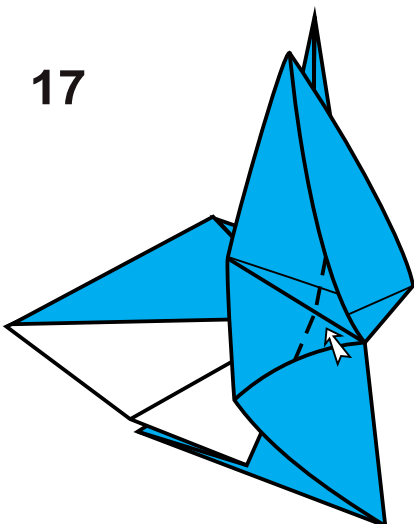

Side view



Squash flat into a triangle with the central line perpendicular to the overall vertical axis

18

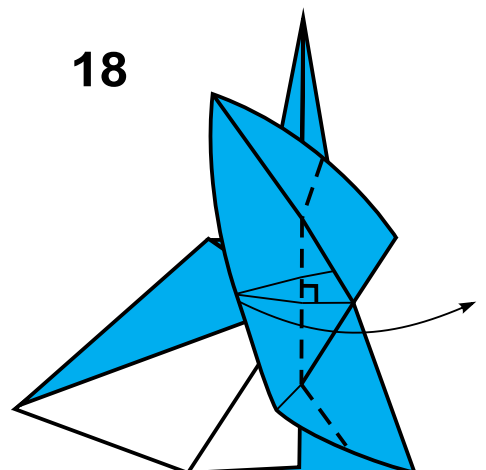

19

20

21

16 - 18

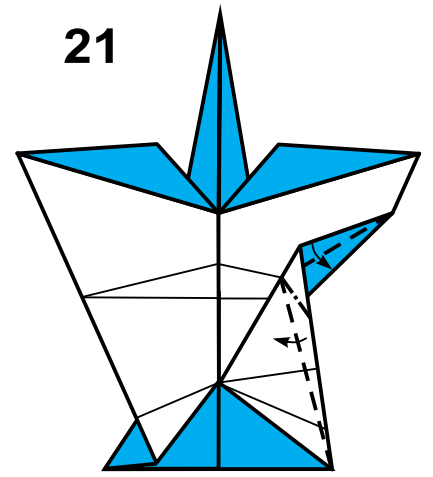
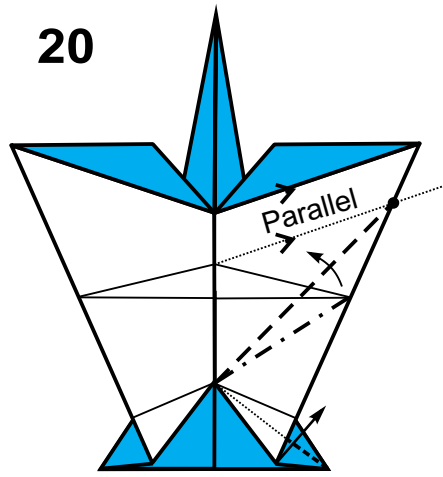
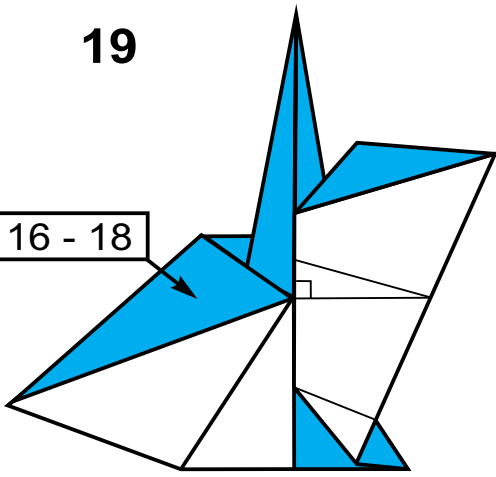

22

23

24

20 - 21

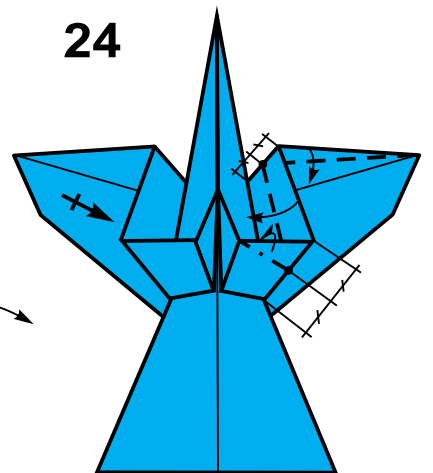
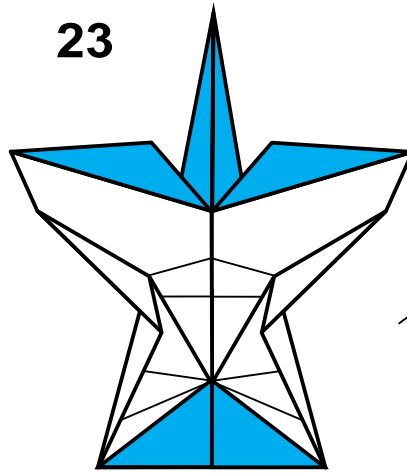
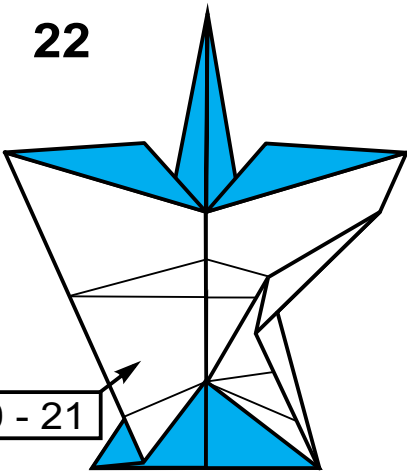

25

26

27

swivel back

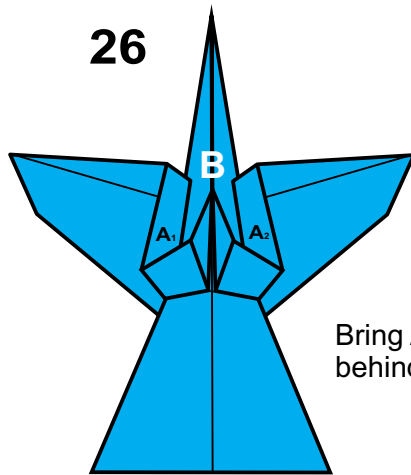
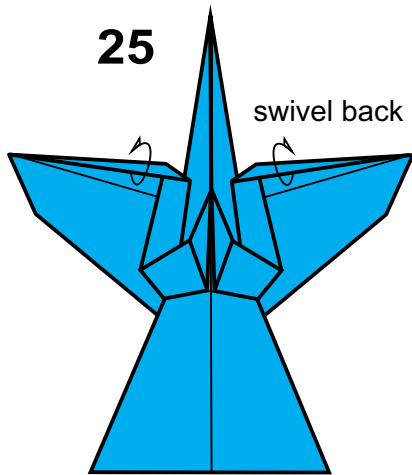

Bring A1&A2 behind B

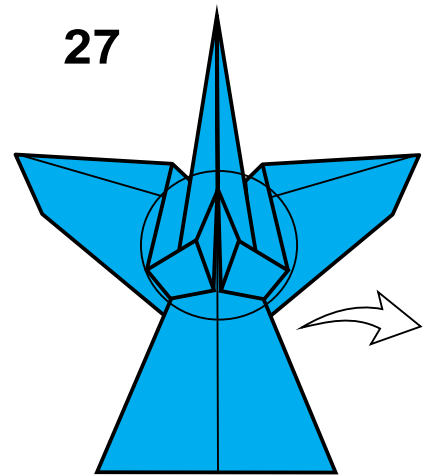

28

29

30

31

X-ray

28 - 29

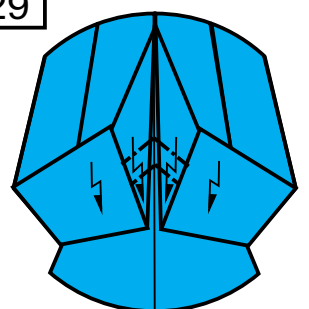
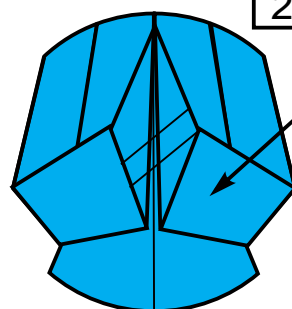
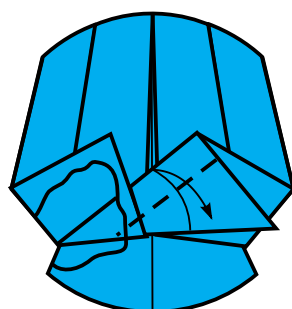
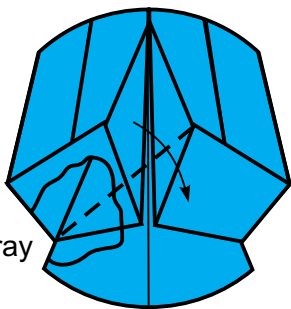

Make crease & unfold back to step 28

Repeat on the right

32

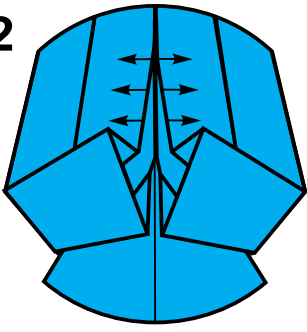

Make 3D hands

33

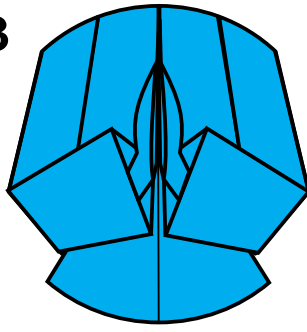

34

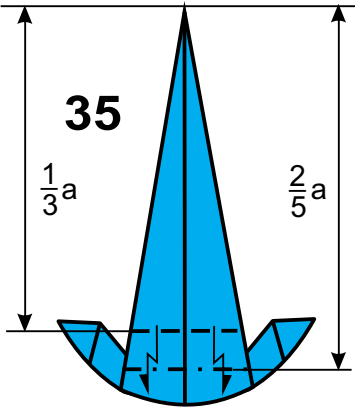
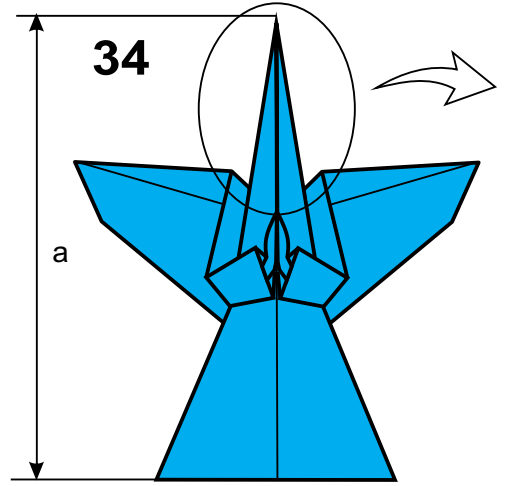

36

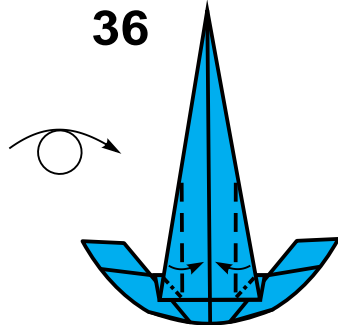

37

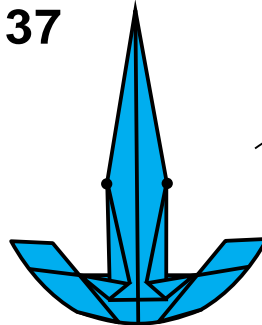

38

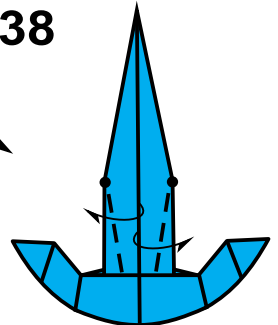

39

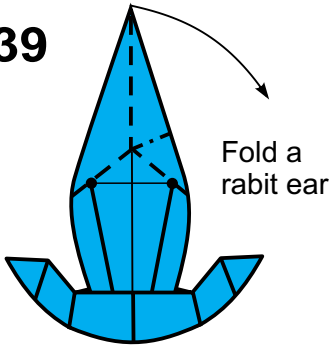

40

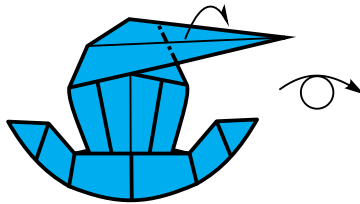

41

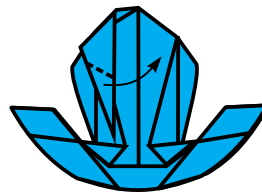

42

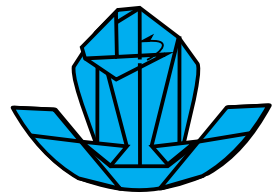

Tuck inside

43

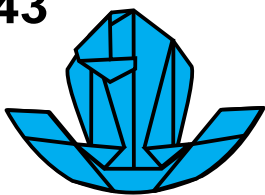

44

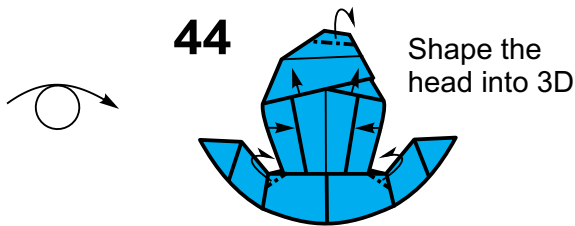

46

Complete

45

Shape wings, make 3D sleeves, move the wings back and forth to help balance the model

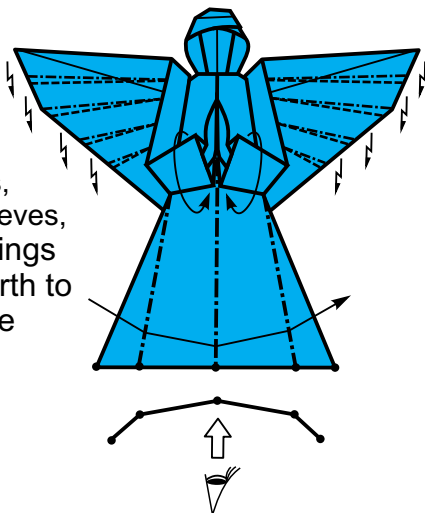

Bottom view

